



Lockable i-Center™ 40"W x 6"D x 25 1/2"H with space for CPU and power strip

i-Center™

THE INNOVATIVE, SPACE-SAVING i-CENTER™ is an attractive wall-mounted workstation that enables computer access wherever needed, without utilizing floor space. The i-Center™ includes a fold-down keyboard tray with a damper for smooth operation and a VESA-compliant monitor holder. It accommodates any standard computer and turns empty wall space into a handy work area.

The i-Center™ features a laminated front and side wall that can be specified to match room décor, and mounts easily with grommet holes to allow cabling. It has a removable front panel with security screws to prevent theft. The i-Center™ was designed to make the most of limited space in today's busy environments.

Features and Benefits

- Removable front panel with security screws and lock for keyboard shelf prevent theft
- Fold-down keyboard tray with damper for smooth operation
- VESA-compliant monitor holder
- Grommet holes for cabling
- Laminated front and side wall can coordinate with room décor
- Multiple colors available (for standard colors, see page 95)
- Optional accessories include: CPU, mouse holder, scanner holder, and cable management
- Custom sizes available

Specifications

- Width: 21 1/8" – 40"
- Height: 25 1/2" – 50"
- Depth: 6" – 9"
- Keyboard shelf depth: 8"

More Options for CPU



i-Center™ with CPU holder # CPU-903-18-5-18



i-Center™ with CPU holder # CPU-08



i-Center™ with matching CPU enclosure

- A.** i-Center™ 27"W x 6"D x 25 1/2"H with holder for thin client PC and retractable mouse tray

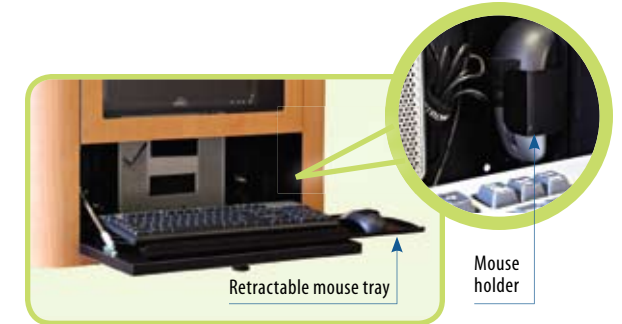
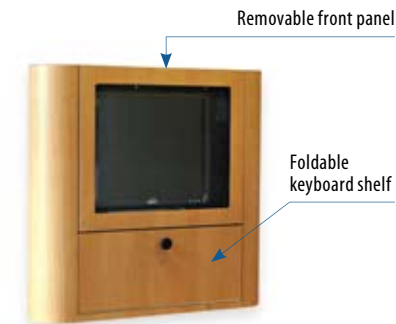

- B.** Lockable i-Center™ 27"W x 6"D x 35"H with wall-mount CPU enclosure for small-form-factor PC and scanner holder

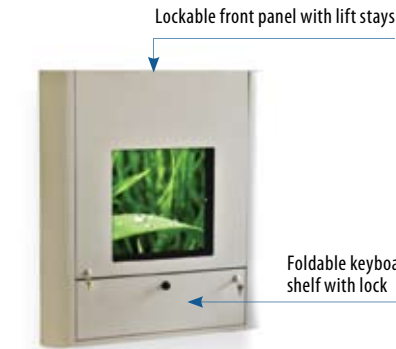

- C.** i-Center™ 25 1/2"W x 6"D x 46 1/2"H with top flip-open-door CPU compartment and retractable mouse tray



The Z-arm allows you to position your monitor at any viewing level, angle, and depth from the viewer.

- D.** i-Center™ 21 1/2"W x 6"D x 49"H with two-door CPU compartment, mouse holder, and retractable mouse tray



- E.** i-Center™ 34"W x 9"D x 50"H with top flip-open-door CPU compartment and Z-arm Combo



Wall Mount # AFC7808_12 with CPU holder # CPU101

Wall Mounts

INTRODUCING WALL MOUNTS AFC7808_12 & AFC7810_20, a height-adjustable, low-profile, user-friendly solution for access to electronic records where space is at a premium. The wall mount accommodates most operators, in sit-to-stand positions. When not in use, it folds up neatly to the wall, tucked away and unobtrusive.

The flexible AFC7808_12 and AFC7810_20 are designed with the ergonomic intelligence, strength, durability, and thorough disinfection properties like other AFC products, while offering an easy-to-operate tool for boosting productivity any high-traffic areas. They are pneumatically height-adjustable within a 12" range, and can be locked in any position you chose. Full range of swivel motion at each joint comfortably accommodates different positions and applications, such as sharing information with patients and other professionals in proximity.

Features and Benefits

- Light-weight aluminum construction for easy operation
- Entire mount is powdered coated in anti-microbial paint for thorough disinfection for safe use throughout medical facilities
- 41" of horizontal extension from the wall with option of supplemental one foot extension arm
- 12" range of height adjustment for accommodation of most users while standing or seated
- Height locking mechanism at any position for safety, stability, and varying loads
- Full range of swivel motion at each joint
- Keyboard folds for low profile and has a safety lock
- Mouse tray can be attached to the left or right side of the keyboard
- Mouse holder is included
- VESA 75/100 compliant monitor bracket with horizontal and vertical tilt and 3" range of height adjustment
- Standard color: Textured Gray (call for custom colors)
- Integrated wire management
- Arm vertically adjusts on 36" wall track (wall track is optional)
- Can be mounted directly on a wall (# AFC7808_12_WMP-01, pg. 92) or desk (# AFC7808_12_DM-01, pg. 91)

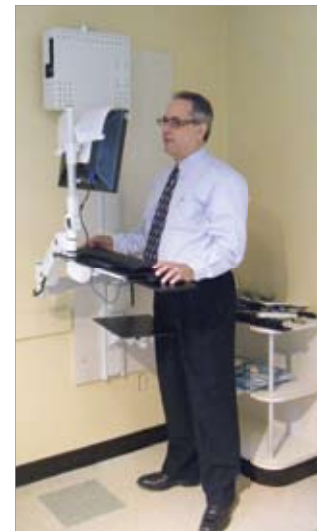

Wall Mount # AFC7810_20 with CPU holder # CPU-919 and shelf on articulating arm

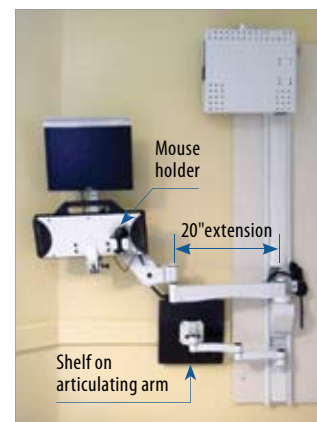

When not in use, it folds up tight to the wall, tucked away and unobtrusive

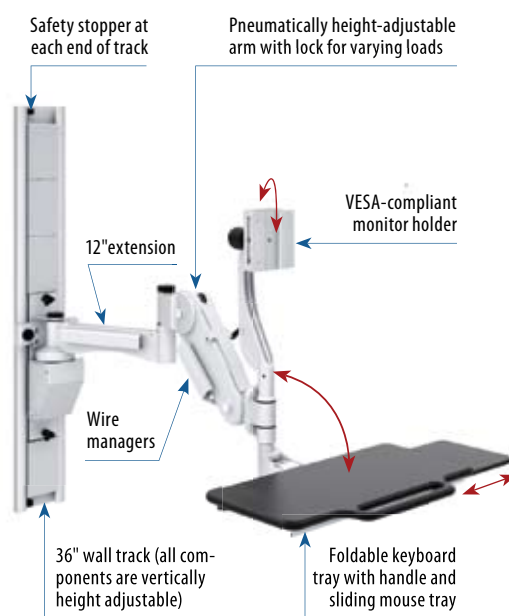

Wall Mount # AFC7808_12

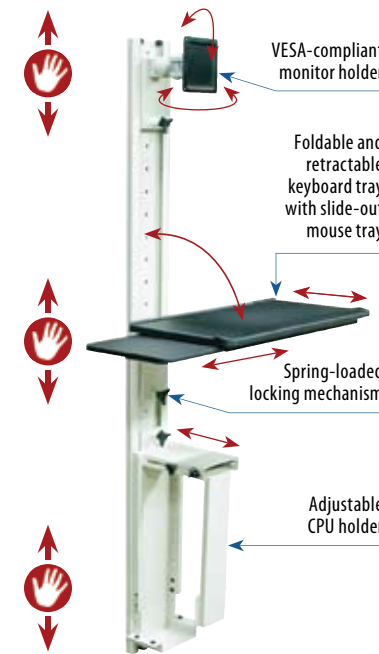

Wall Mount # WM-RKMC

Features and Benefits

- All components are individually adjustable in increments of 2"
- Safety stopper at both ends
- Spring-loaded locking mechanism for simple and easy height adjustment
- VESA-compliant monitor holder that can be adjusted from portrait to landscape view and tilted to avoid glare
- Foldable and retractable keyboard arm and mouse tray
- Adjustable CPU holder (3 1/2" - 8 1/2"W, 13" - 25"H)
- Multiple colors available (for standard colors, see page 95)
- Additional accessories available (see page 84)

Optional

- Horizontal or vertical positioning
- Double monitor holder on single track (see sidebar "Optional Monitor Arms for Wall Mount" on page 72)
- Horizontal track for multiple monitors (see sidebar "More Wall Mount Solutions..." on page 72)
- UPS Holder
- Mouse Holder

Electronic Adjustment:

UNIT HEIGHT



A. Wall Mount with electronic height adjustment # WM202-01

- 19" of electronic height adjustment
- Components are individually adjustable
- Monitor Arm # AFC22
- Foldable keyboard tray with retractable mouse tray
- Adjustable CPU holder # CPU101

Pneumatic Adjustment:

UNIT HEIGHT

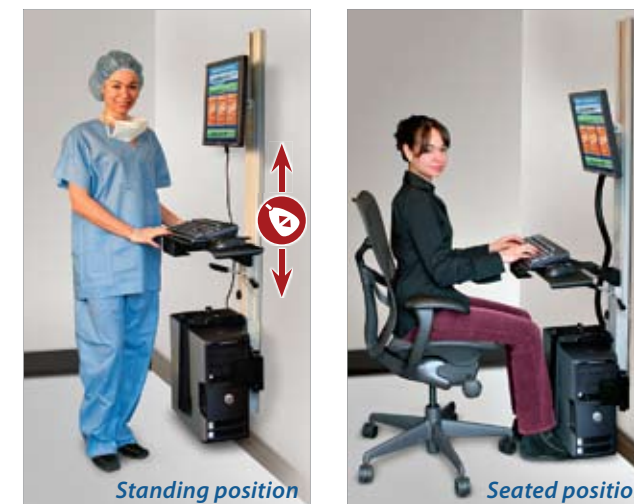

B. Wall Mount with pneumatic height adjustment # WM-RKMC-P-04

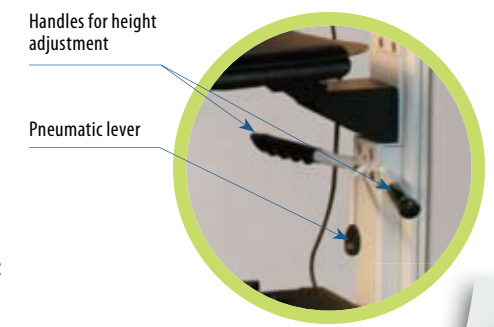

C. Wall Mount with monitor arm # AFC7808M, keyboard arm # AFC7808K, and CPU holder # CPU-101

D. Wall Mount # WM36-M1-FK-C1¹
 1 OSHPD rated

More Wall Mount Solutions...

Wall Mount pole # WMPC_72_F_KB_2C_01

CPU holder # CPU 13-25
I. Wall Mount # WM-C-AFC78-01
 Seated position

Standing position

Pneumatically height-adjustable arm with lock for varying loads (12" stroke)
 Foldable keyboard tray with sliding mouse tray and handle
L. Wall Mount # AFC7808_01_WMP-01

Optional Monitor Arms for Wall Mounts

Twin monitor arm # 2MH

Z-series monitor arm for one monitor

Z-series monitor arm for two monitors

E. Wall Mount # WM-RKMC
 Mouse holder

Wire management cover
 Z-series keyboard arm
 12"x12" printer shelf
 CPU holder # CPU-101
F. Wall Mount # WM-56-1F-1KBZ-1C-01

Wall Mount for multiple monitors on horizontal track # WM110_3PLE18_3F

CPU holder # CPU-903-18-5-18
 Scanner holder
 Foldable shelf
J. Wall Mount with CPU holder, scanner holder, and foldable shelf # WM56_Z200_CMB_1C_12SH_01

CPU holder # CPU-101
M. Wall Mount # WM36-C101-AFC78-01

UPS platform
G. Wall Mount # WM-RK2ZMC-U

H. Custom Wall Mount with Z-series scanner tray, Z-series keyboard tray, and printer shelf

Safety stopper at each end of track
 Laptop tray 16"Wx12"D with handle
 2" Grommet hole
Laptop Wall Mount # AFCZ566-01-LWM-01

CPU holder # CPU-903-18-5-18
K. Custom Wall Mount with Z-series combo arm, CPU holder, and foldable shelf

21" extension
 Wire basket
N. Wall Mount # WM-C-AFC78-21-01 with CPU holder and wire basket

Configure your own Wall Mount with our **INTERACTIVE BUILDER** at www.afcindustries.com/wallmount



Three-row Video Wall for 15 monitors

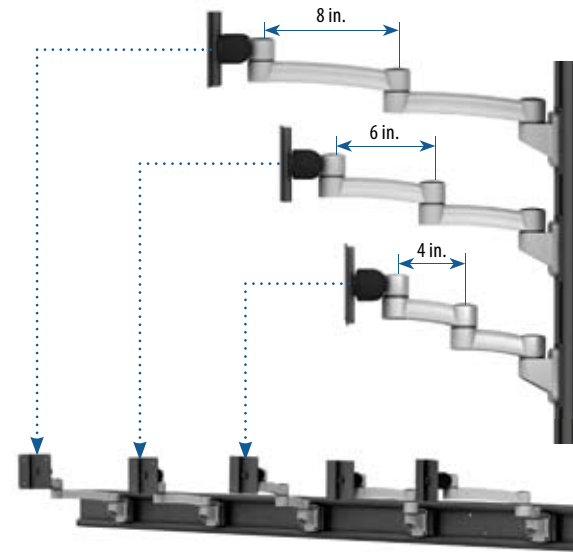

Video Wall

THE VIDEO WALL consists of one or more tracks for sliding the monitor arms from left to right, where every single arm allows tilting up-down and left-right, as well as micro-adjustment to eliminate gaps between monitors. Z-arms give each monitor an ample range of motion, allowing you to position them in several different viewing arrangements.

Features and Benefits

- Aluminum track with mounting holes and safety stopper at both ends allows monitor holders to slide
- Horizontal or vertical mounting of tracks
- Z-arm monitor holders with extension, tilt, and pan motion; arms have varying length to provide parabolic shape for optimum viewing
- VESA-compliant monitor holder that can be adjusted from portrait to landscape views and tilted to avoid glare
- Combination setup allows horizontal and vertical adjustment of the monitors
- Monitor travels from 4" to 20" from the wall
- Multiple colors available (for standard colors, see page 95)

Optional

- Monitor holders # AFC16, # AFC18, # AFC22 (tilt and pan only)
- Non VESA-compliant monitor holders available for larger flat screens

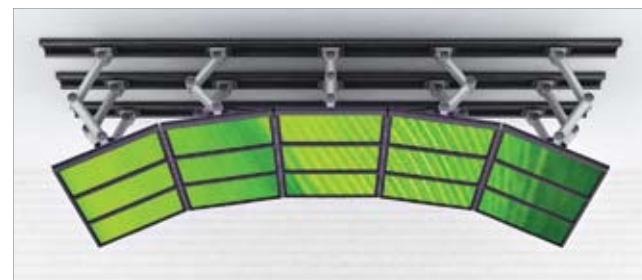

The outer monitor arms are longer than at the center, which lets you create a comfortable viewing arc. When laid out straight, the monitors can get as close as 4" to the wall.



The Video Wall's freedom of motion allows you to combine monitors of different shapes and sizes, in any arrangement, without gaps.



Floor Post
FM50_1F_1AFC7808K
1C_1WB_00-01



Floor Post # FP04



Floor Post # FP06



Based on your specifications, you can create unlimited configurations suitable for any task

Floor Post

AFC'S NEW FLOOR POST SERIES™ creates a more effective, comfortable, and productive work environment. Based on your specifications, you can have unlimited configurations for any task. Its space saving design also allows multi-side (front/back/side) user capability.

The **Floor Post Series™** can be mounted to various floor surfaces. Monitor, keyboard arms, CPU holders, shelves and other accessories can be made height adjustable on a secure track making the **Floor Post Series™** suitable for multi-users.

Features and Benefits

- All components are individually adjustable
- Spring-loaded locking mechanism for simple and easy height adjustment (depending on item)
- Built-in wire management
- Monitor holders of your choice: AFC10E/F/G, AFC16, AFC18, AFC22, AFCZ500, AFC7808M_01_WM-01 (see page 90)
- CPU holders of your choice: CPU-101, CPU13-25, CPU-08, or CPU-09 (see page 92)
- Multiple colors available (for standard colors, see page 95)
- Additional accessories available (see page 84)

Specifications

- Base footprint: 16"W x 16"D
- Overall height from the floor: 60"

Optional

- Double-monitor holder
- Foldable and retractable keyboard arm and mouse tray
- Additional shelves
- Camera holder



Floor Post
FM50_1F_WS3018
1KB_1C_1WB_00-01



Floor Post
FM50_1F_1AFC7808M
1C_1WB_00-01



Floor Post # FP07