

Protective Barriers

Infab radiation protection barriers incorporate quality features not found in any other manufacturers products. Genuine swivel base ball bearing hospital grade casters make maneuverability a breeze while the two locking casters prevent accidental movement once the barrier is positioned. Heavy gauge steel framework is finished with rugged powder coated enamel, an electro magnetic process that bonds the paint to the metal so it won't chip, peel or corrode. 2.0mm optically clear lead glass offers four times the radiation protection of lead acrylic. Each barrier comes standard with our protective framework that encloses 100 percent of the glass and our special clear optical concussion panels to prevent shattering. We even include our exclusive base skirt, a 1.5mm Pb curtain that extends from the base to the floor and compliments the 1.5mm Pb equivalent opaque bottom panel for true head to toe protection.

With nine standard models and the ability to manufacture any custom size you desire we can deliver just what you want and get it to you quickly, usually within 10 days of your order or faster.

With more than 2,000 barriers in service, including 300 units in Iraq medical clinics and not a single return or damaged unit, Infab barriers have the track record to back up the claim "World's Best Radiation Protection Barriers".



Measured Transmission of Infab Barriers vs Lead Plastic

X-Ray Kvp	60	70	80	90	100	110	120	130	140
Infab Protective barriers with 2.0mm rated Pb Equivalency	0.10 %	0.20 %	0.20 %	0.20 %	0.40 %	0.40 %	0.40 %	0.50 %	0.50 %
Clear Pb Lead plastic in same thickness as Infab product	1.40 %	1.60 %	2.40 %	3 %	4 %	5.10 %	5.60 %	6.40 %	7.20 %

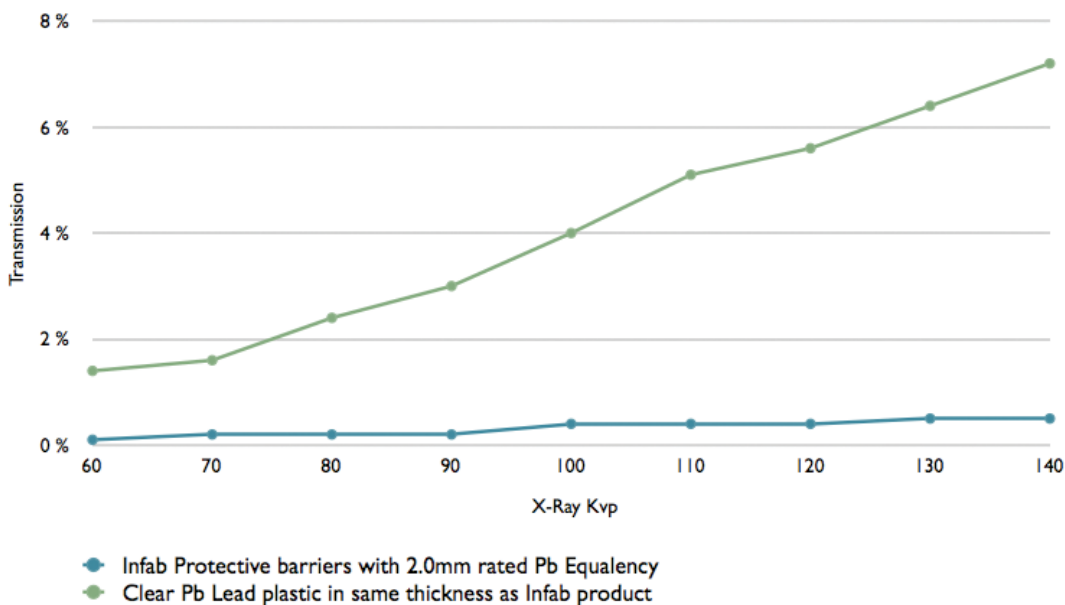

Large Window Mobile Barrier

Powder coated steel frames, precision TIG welded for years of trouble free service completely enclosing the leaded glass panel for increased durability and safety

2.0mm lead equivalent optically clear lead glass encased in clear Lexan to prevent shattering

Exclusive 1.5mm lead equivalent floor drape, the only barriers made with complete head to toe protection

4 hospital grade casters, two with locks for ease of movement and positive positioning



Part Number	683492		
Total Dimensions	Height: 80"	Width: 41"	Depth: 25"
Lead Glass Window Dimensions	Width: 36"	Height: 72"	

X-Tall Mobile Barrier

Powder coated steel frames, precision TIG welded for years of trouble free service completely enclosing the leaded glass panel for increased durability and safety

2.0mm lead equivalent optically clear lead glass encased in clear Lexan to prevent shattering

1.5mm lead equivalent opaque base covered in "Sintra" plastic for easy cleaning and durability

Exclusive 1.5mm lead equivalent floor drape, the only barriers made with complete head to toe protection

4 hospital grade casters, two with locks for ease of movement and positive positioning



Part Number	683476		
Total Dimensions	Height: 80"	Width: 40"	Depth: 25"
Lead Glass Window Dimensions	Width: 36"	Height: 60"	

X-Wide Mobile Barrier

Powder coated steel frames, precision TIG welded for years of trouble free service completely enclosing the leaded glass panel for increased durability and safety

2.0mm lead equivalent optically clear lead glass encased in clear Lexan to prevent shattering

1.5mm lead equivalent opaque base covered in "Sintra" plastic for easy cleaning and durability

Exclusive 1.5mm lead equivalent floor drape, the only barriers made with complete head to toe protection

4 hospital grade casters, two with locks for ease of movement and positive positioning



Part Number	683488		
Total Dimensions	Height: 74"	Width: 76"	Depth: 25"
Lead Glass Window Dimensions	Width: 72"	Height: 36"	

Wide Mobile Barrier

Powder coated steel frames, precision TIG welded for years of trouble free service completely enclosing the leaded glass panel for increased durability and safety

2.0mm lead equivalent optically clear lead glass encased in clear Lexan to prevent shattering

1.5mm lead equivalent opaque base covered in "Sintra" plastic for easy cleaning and durability

Exclusive 1.5mm lead equivalent floor drape, the only barriers made with complete head to toe protection

4 hospital grade casters, two with locks for ease of movement and positive positioning



Part Number	683482		
Total Dimensions	Height: 74"	Width: 52"	Depth: 25"
Lead Glass Window Dimensions	Width: 48"	Height: 36"	

Medium Window Mobile Barrier

Powder coated steel frames, precision TIG welded for years of trouble free service completely enclosing the leaded glass panel for increased durability and safety

2.0mm lead equivalent optically clear lead glass encased in clear Lexan to prevent shattering

1.5mm lead equivalent opaque base covered in "Sintra" plastic for easy cleaning and durability

Exclusive 1.5mm lead equivalent floor drape, the only barriers made with complete head to toe protection

4 hospital grade casters, two with locks for ease of movement and positive positioning

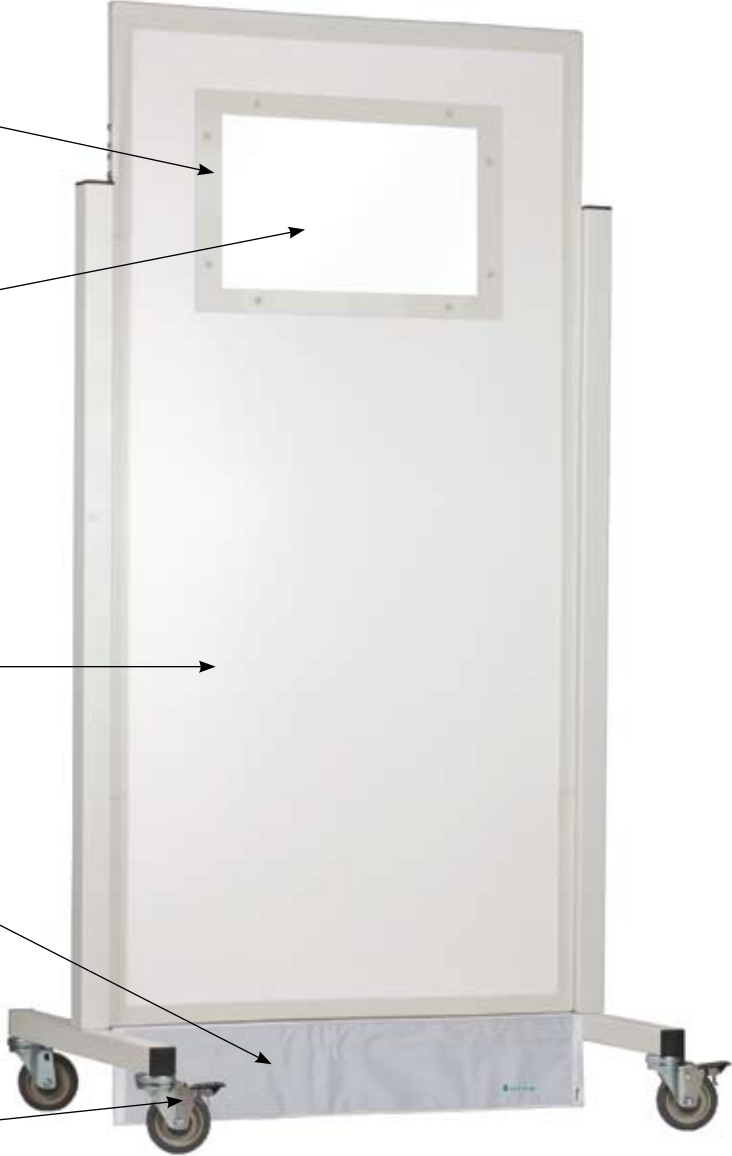

Part Number	683468		
Total Dimensions	Height: 74"	Width: 52"	Depth: 25"
Lead Glass Window Dimensions	Width: 24"	Height: 12"	

Small Window Mobile Barrier

Powder coated steel frames, precision TIG welded for years of trouble free service completely enclosing the leaded glass panel for increased durability and safety

2.0mm lead equivalent optically clear lead glass encased in clear Lexan to prevent shattering

1.5mm lead equivalent opaque base covered in "Sintra" plastic for easy cleaning and durability

Exclusive 1.5mm lead equivalent floor drape, the only barriers made with complete head to toe protection

4 hospital grade casters, two with locks for ease of movement and positive positioning



Part Number	683465		
Total Dimensions	Height: 74"	Width: 52"	Depth: 25"
Lead Glass Window Dimensions	Width: 12"	Height: 12"	

Standard Mobile Barrier

Powder coated steel frames, precision TIG welded for years of trouble free service completely enclosing the leaded glass panel for increased durability and safety

2.0mm lead equivalent optically clear lead glass encased in clear Lexan to prevent shattering

1.5mm lead equivalent opaque base covered in "Sintra" plastic for easy cleaning and durability

Exclusive 1.5mm lead equivalent floor drape, the only barriers made with complete head to toe protection

4 hospital grade casters, two with locks for ease of movement and positive positioning

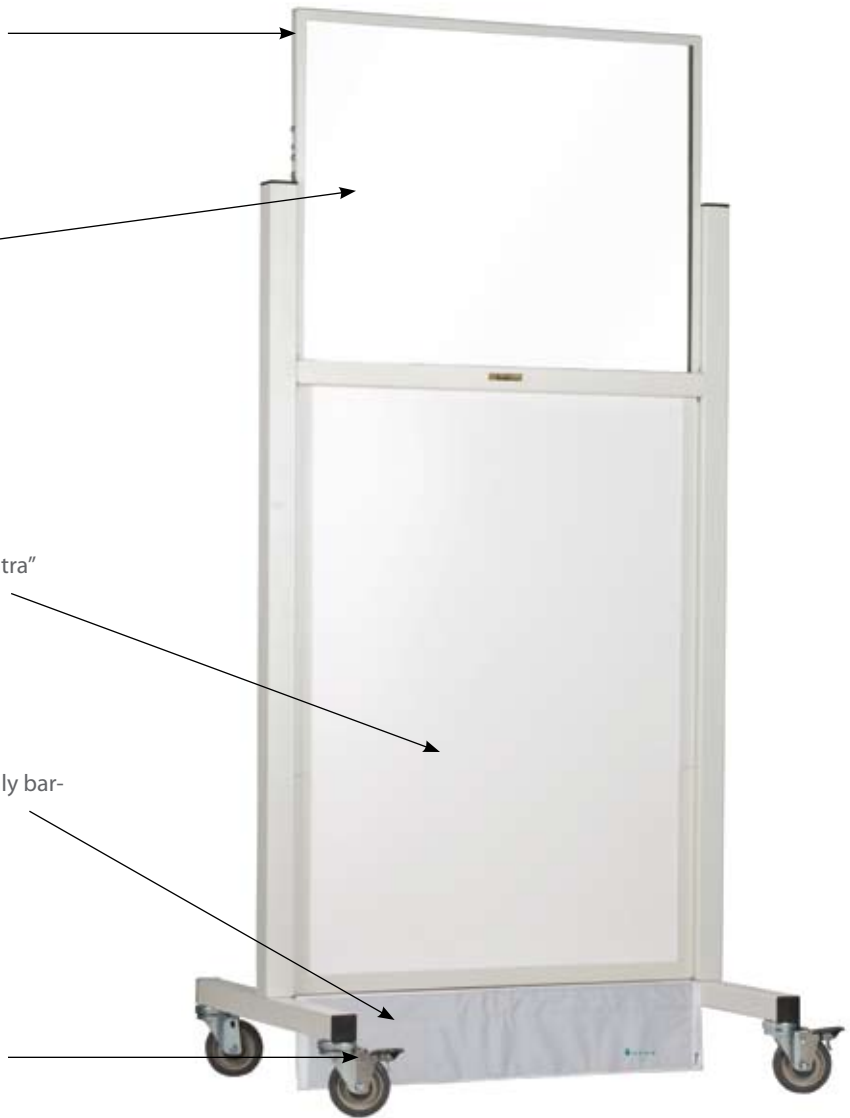

Part Number	683460		
Total Dimensions	Height: 73"	Width: 34"	Depth: 25"
Lead Glass Window Dimensions	Width: 30"	Height: 24"	

Regular Mobile Barrier

Powder coated steel frames, precision TIG welded for years of trouble free service completely enclosing the leaded glass panel for increased durability and safety

2.0mm lead equivalent optically clear lead glass encased in clear Lexan to prevent shattering

1.5mm lead equivalent opaque base covered in "Sintra" plastic for easy cleaning and durability

Exclusive 1.5mm lead equivalent floor drape, the only barriers made with complete head to toe protection

4 hospital grade casters, two with locks for ease of movement and positive positioning



Part Number	683484		
Total Dimensions	Height: 65"	Width: 40"	Depth: 25"
Lead Glass Window Dimensions	Width: 36"	Height: 24"	

“Shorty” Mobile Barrier

Powder coated steel frames, precision TIG welded for years of trouble free service completely enclosing the leaded glass panel for increased durability and safety

2.0mm lead equivalent optically clear lead glass encased in clear Lexan to prevent shattering

1.5mm lead equivalent opaque base covered in “Sintra” plastic for easy cleaning and durability

Exclusive 1.5mm lead equivalent floor drape, the only barriers made with complete head to toe protection

4 hospital grade casters, two with locks for ease of movement and positive positioning



Part Number	683458		
Total Dimensions	Height: 46"	Width: 34"	Depth: 25"
Lead Glass Window Dimensions	Width: 30"	Height: 24"	

Custom Barrier Form

(Can also be downloaded from www.infabcorp.com)



Infab can build a radiation protection barrier to any specification, mobile, wall, floor or ceiling mounted. Send us your drawings, tell us your ideas and let us create exactly what you need.

Quantity	Overall height	Overall length	Window size	Lead equivalency

Special instructions:

Radiation Protection Curtains

Manufactured to your exact specifications



Infab Corporation Radiation Protection Curtains and Tracks are custom manufactured to your exact drawing or specifications. Any size, any lead equivalency any configuration is available and quickly shipped, usually within ten days or less.

All curtains are manufactured from our high quality lead vinyl core material and covered in your choice of any of our 2,000 durable poly cloth colors and prints. Each curtain comes standard with a grommet, "S" hook and heavy duty track glide every six inches along the width of the curtain. Heavy gauge theatrical curtain track is available in 20 foot continuous lengths for both straight and curved applications. Curtain track can be pre bent by our factory technicians to your specifications or field bent with the purchase of our handy track bending tool. Give us a call to discuss all of your needs and for a prompt and complete quotation.

Model	Description
683650	.25mm Pb curtain with Grommets (per sq. ft)
683660	.50mm Pb curtain with Grommets (per sq. ft)
683670	.75mm Pb curtain with Grommets (per sq. ft)
683675	1.0mm Pb curtain with Grommets (per sq. ft)
683680	Straight Mounting Track and Glides for curtains (per linear ft.)
683690	Curved Mounting Track and Glides for curtains (per linear ft.)

NOTE: Due to varying conditions and construction types Infab Corporation does not provide mounting hardware or mounting recommendations. Please consult the building engineers for mounting instructions.

Radiation Protection Curtain Track and Accessories

for **Straight** Track Applications

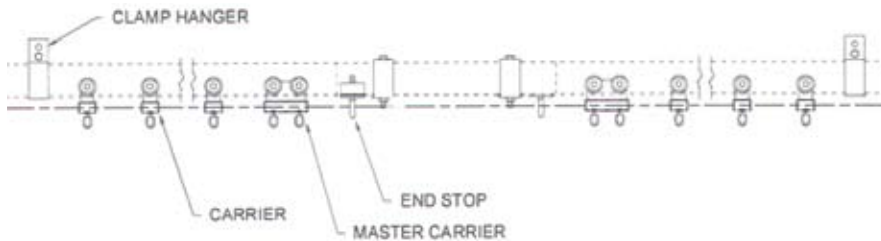

Single Carrier

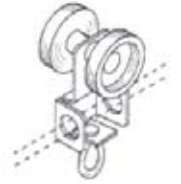

2 polyethylene wheels riveted to plated steel body with swivel hook.

Model Number

683691

Master Carrier

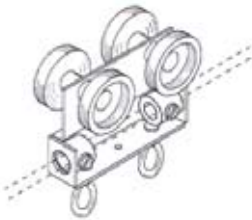

4 polyethylene wheels rivited to steel body with 2 swivel hooks. Supplied with 2 clamps for anchoring operating line or cable. 1 pair required for overlapping tracks.

Model Number

683692

Clamp Hanger

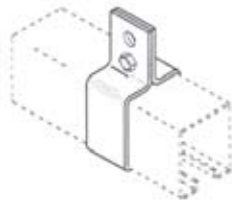

Formed steel brackets clamp to track. Adjust to any position. Suspend track with welded chain or wire rope.

Model Number

683693

Track

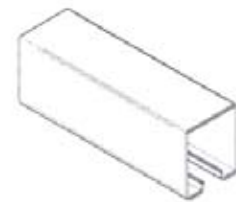

Mill finish 6063-T5 extruded aluminum 1-3/4" wide x 2" high, .080 thick. 20' and 24' stock lengths.

Model Number

683680

End Stop

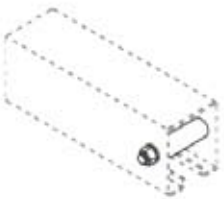

Bolt with horizontal pipe spacer to prevent carriers from traveling beyond desired location. For use with walk-along tracks.

Model Number

683694

Ceiling Splice

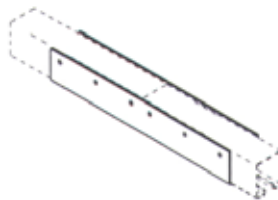

To align and lock track sections together on ceiling mounted tracks.

Model Number

683695

Trim Chain



3 links No.10 single jack chain added to carriers to provide 3" of curtain height adjustment.

Model Number

683696

Radiation Protection Curtain Track and Accessories

for **Curved** Track Applications

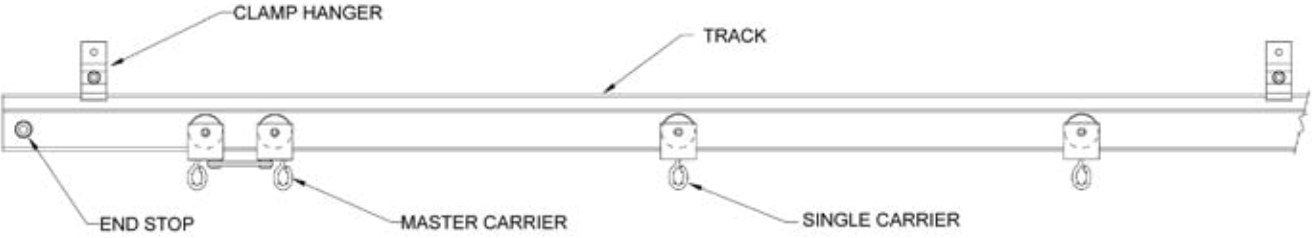

Mounting Track for Curtains



Mill finish 6063-T5 extruded aluminum 5/8" wide x1-11/16" high, .0094" thick. 20 foot stock length. (can be cut to desired length) For curved track applications only. Priced per foot.

Model Number	Description
683680	Straight mounting rack per linear ft
683690	Curved mounting rack per linear ft

Ceiling Hanger

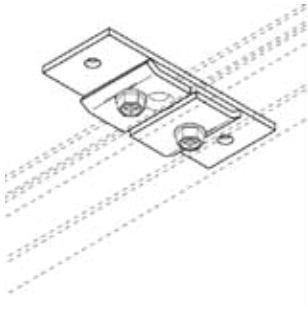

Steel plate mounts flush to ceiling. Track clamps to bracket with offset clips.

Model Number	Description
683684	Ceiling Hanger

Single Carrier



Nylon-tired shielded ball bearing wheels riveted to extruded aluminium body with swivel hook. Nylatron glide reduce friction and noise.

Model Number
683682

Master Carrier

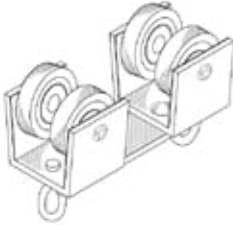

2 nylon-tired shielded ball bearing wheel assemblies with swivel pivot on steel connecting plate. 1 pair recommended for each walk-along curtain.

Model Number
683681

End Stop

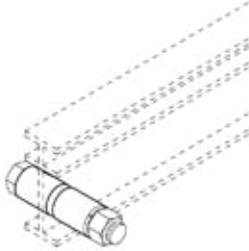

Bolt with steel spacers to prevent carriers from travelling beyond desired location. 1 pair required for each track.

Model Number
683683

Solid Panel Mobile Curtain

- Adjustable height between 36" and 56"
- 24" wide by 24" tall lead vinyl curtain
- Infabs Exclusive Squeeze type Handle for easy and safe adjustments
- 5 caster base design helps to stabilize the unit
- Smooth and easy maneuvering



Model	Description
683564	.25mm Pb Solid Panel Adjustable Height
683565	.50mm Pb Solid Panel Adjustable Height
683566	.75mm Pb Solid Panel Adjustable Height
683567	1.0mm Pb Solid Panel Adjustable Height

Split Panel Mobile Curtain

- Panels can be separated to accomodate equipment, I.V.'s, etc
- Adjustable height between 36" and 56"
- 24" wide by 24" tall lead vinyl curtain
- Infabs Exclusive Squeeze type Handle for easy and safe adjustments
- 5 caster base design helps to stabilize the unit
- Smooth and easy maneuvering

Model	Description
683564-S	.25mm Pb Split Panel Adjustable Height
683565-S	.50mm Pb Split Panel Adjustable Height
683566-S	.75mm Pb Split Panel Adjustable Height
683567-S	1.0mm Pb Split Panel Adjustable Height



Mobile Radiation Protection Curtain

- Custom manufactured to your exact specifications
- Available in any of our nylon or vinyl colors and trims
- Nylon track glides
- Heavy duty carriers
- 4 caster base design on each side helps to stabilize the unit
- Smooth and easy maneuvering
- Opening allows easy passage of people and/or equipment
- Velcro tie back straps



Model	Description
683589	.25mm Pb Mobile Radiation Protection Curtain/per square foot
683590	.50mm Pb Mobile Radiation Protection Curtain/per square foot
683591	1.0mm Pb Mobile Radiation Protection Curtain/per square foot

Table Mounted Scatter Curtain

- Universal product
- A full size 24" wide and 32" long
- .50mm Pb curtain
- Universal anodized aluminum side rail mounting bracket
- Adjustable height arm is stainless steel with dual adjustment screws
- Choice of any of our more than 2,000 covering materials
- Mounts easily and quickly with the special bracket provided



Model	Description
683570	Table Mounted Scatter Curtain

Table Curtain Mounting Bracket

- 6061-T6 aircraft grade aluminum
- Black anodized
- Adaptable to all tables with side rails that fall within 3/16" thick by 1-3/8" high
- Dual adjustment screws
- Vertical and lateral adjustment

Fits 3/16" thick rails 1 3/8" wide

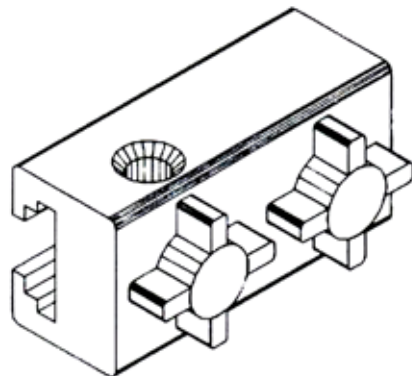

Model	Description
683571	Table Curtain Mounting Bracket

Saddle Shield Radiation Protection Curtain System

Infab is pleased to introduce our latest innovation in radiation protection, the "Saddle Shield". Choose from a standard size or have one built to your specifications and dimensions, these double sided protective curtains drape over the table, just like a saddle, and significantly reduce scatter radiation.

No special hardware or modifications to the imaging equipment are required!! Curtains are counterbalanced and are easy to install and remove

Overlapping split panels make it easy to access under the table if needed and do not restrict movement when you are standing tableside.

Infab Saddle Shields come standard with .50mm radiation protection on two sides but can be easily customized to enclose two sides and the leading edge at the front of the table.

Choose from any of our more than 2,000 colors and fabric styles. Comes standard with .50mm lead protection, but can be modified with a higher or lower level of protection.

We currently manufacture three standard configurations, however there is no extra fee for customization, we only charge for the actual square footage of the curtain. Due to the highly specialized nature of these new and innovative radiation protection curtains, we have provided a guideline for custom measurements. Please give us a call, send us a drawing or an e-mail and we will quickly quote your requirements and/or help you to design the perfect product for your table and environment. For specialized products at production prices, Infab is the name you have counted on for more than thirty years.

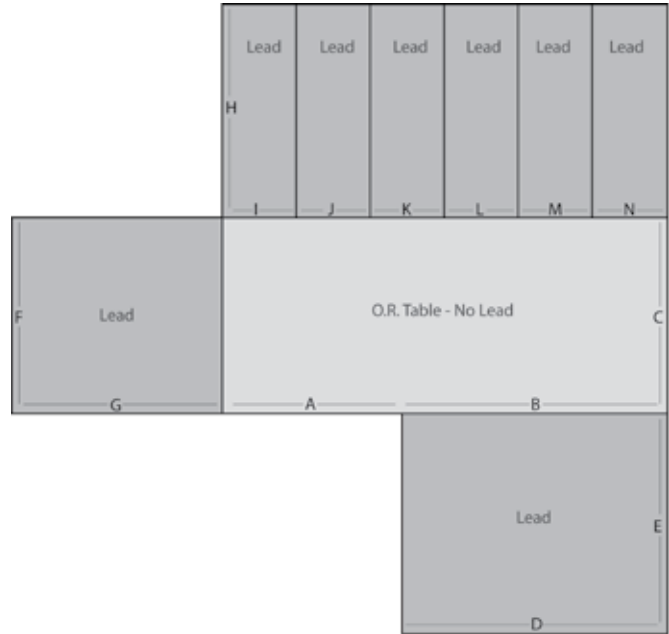

	Dimension		Dimension
A:		F:	
B:		I:	
C:		J:	
D:		K:	
E:		L:	
F:		M:	
G:		N:	

Mm. Pb.: _____

Notes: _____

Model	Description
990002	Radiation protection Saddle Shield curtain for 20" wide tables/.50mm lead
990004	Radiation protection Saddle Shield curtain for 24" wide tables/.50mm lead
990006	Radiation protection Saddle Shield curtain for 27" wide tables/.50mm lead
990007	Radiation protection Saddle Shield curtain/ Custom size and configuration/Specify