



Quality



MIDMARK MODULAR CASEWORK CATALOG

## TABLE OF CONTENTS

General Information .....	4
Value Engineering Suggestions.....	5
Midmark Cabinet Cutaway .....	6
Midmark Casework Series.....	7
Ritter Cabinet Cutaway.....	8
Ritter Casework Series .....	9
Test Data Sheet.....	10 - 11
Midmark Modular Casework Order Policy .....	12
Shipping Policy.....	13
Modular Casework Limited Warranty .....	14
Base Exam — Sink/Storage Units .....	15 - 18
Base Sink Units .....	19 - 22
Base Sink Unit - Meet ADA Requirements -  .....	22
Base Storage Units .....	23 - 33
Base File Units .....	33 - 35
Base Corner Units .....	35 - 38
Floor Base Options.....	39 - 40
Sinks .....	42
Faucets .....	43 - 44
Sink/Accessories .....	45
Tall Storage Units .....	46 - 50
Tall Unit Options .....	50 - 51
Hanging, Standing and Mobile Desks.....	52 - 53
Desk Unit Options .....	53 - 55
Overhead Cabinets.....	56 - 61
Overhead Narcotics Cabinets.....	62
Corner Overheads .....	63 - 66
Overhead Options .....	67 - 69
Mobile Carts.....	70 - 73
Mobile File .....	74
Mobile Options.....	75
Specialty Units.....	76
Laminate and Corian® Countertops .....	77
Countertop Accessories .....	78 - 79
General Accessories.....	80
Midmark Exam Room Casework .....	81 - 82
Ritter Exam Room Casework .....	83 - 84
Notes .....	85 - 87

## GENERAL INFORMATION

### MIDMARK vs RITTER

Midmark offers two lines of casework that aesthetically match the Midmark and Ritter exam tables. The Midmark line coordinates more easily with the Midmark tables, whereas, the Ritter line coordinates more easily with the Ritter tables. Please note that a Midmark line cabinet can be used with a Ritter style table provided that colors are selected carefully for both products. Please see summary below or product specifications for more details.

**Midmark** – Pebble Grey paint on metal; Pebble Grey polymer-covered door and drawer fronts. See color chart for color options on door/drawer pull inserts.

*Advantages* – full featured medical casework, easier to clean than laminate; more chemically resistant; rounded corners on drawers and doors; labeling system available; plexiglass door front options. Interior modularity.

**Ritter** – Pebble Grey paint on metal; Pebble Grey handles. See color chart for colors available on door/drawer fronts.

*Advantages* – basic medical features, more economical.

### COUNTERTOPS

Midmark's standard countertop is a seamless (up to 144"), one piece laminate with a 180° postformed front and a backsplash. Solid surface countertops are also available in standard colors. Midmark can source virtually any countertop surface desired. See our standard color chart for color options. Please call **1-800-MIDMARK**, ext. 8914 for an estimate on cost and delivery times.

### DRAWERS

This catalog offers drawer configurations that are most commonly requested. When selecting your personal configuration please note that the names of the drawers are not exact measurements. The ratio of the heights of the 2", 4" and 8" drawers are 1:2:4. Therefore, since a 30" high base cabinet can accommodate two 8" drawers, it could also accommodate four 4" drawers or eight 2" drawers. A pullout writing surface can also replace a 2" drawer in the 24" wide and 30" wide base units.

In the Midmark line, any base storage unit can be easily converted from drawers to doors or vice versa after installation.

### OPTIONS

Locks are available as individual door locks or as a central locking system for drawers. Sloping tops can be added to overhead units and tall units. Task lights are available in 18" and 36" lengths, which may be hard wired, corded or daisy chained.

\*Midmark and Ritter for primary and acute care markets. Dental markets use Midmark only.

## VALUE ENGINEERING SUGGESTIONS

- Exam room combination units are by far the most economical method of using Midmark Casework in the medical environment. Check to see if one of the configurations fits your needs. (See pages 81-84)
- Base combination cabinets offer cost savings with many configuration options.
- Converting small overhead cabinets to larger overhead cabinets.  
For example, a 48" wide overhead is significantly lower in cost than two 24" wide units.
- Reducing the number of drawers in base units by using larger drawers or by converting to bulk storage areas.
- The Ritter cabinetry is less expensive than the Midmark cabinetry.

## MODEL NUMBERS

Please see display below for an explanation on Modular Casework model numbers.

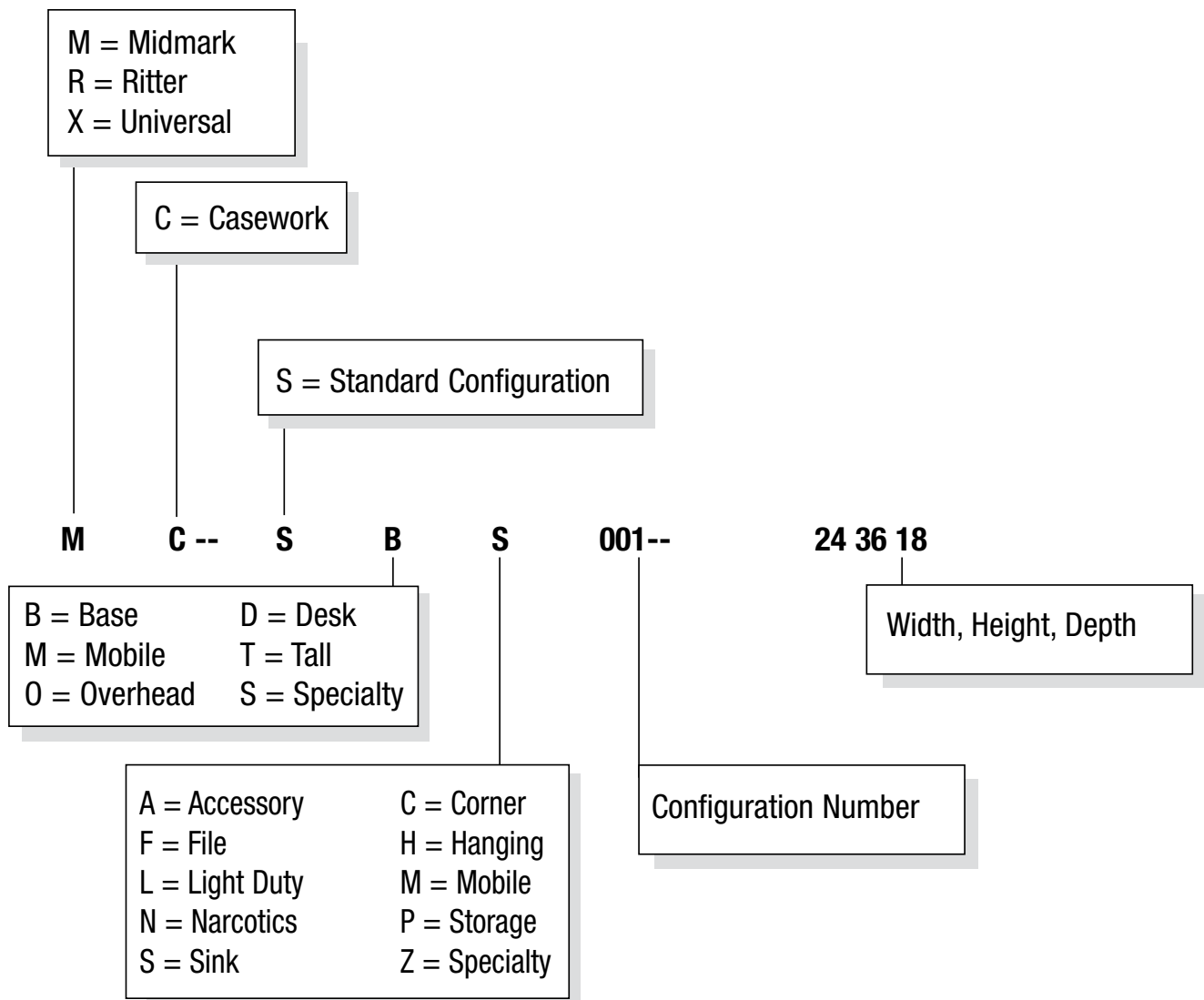

\*Dimensions in this book are nominal external dimensions. Contact Midmark for actual dimensions.

# MIDMARK CABINET CUTAWAY

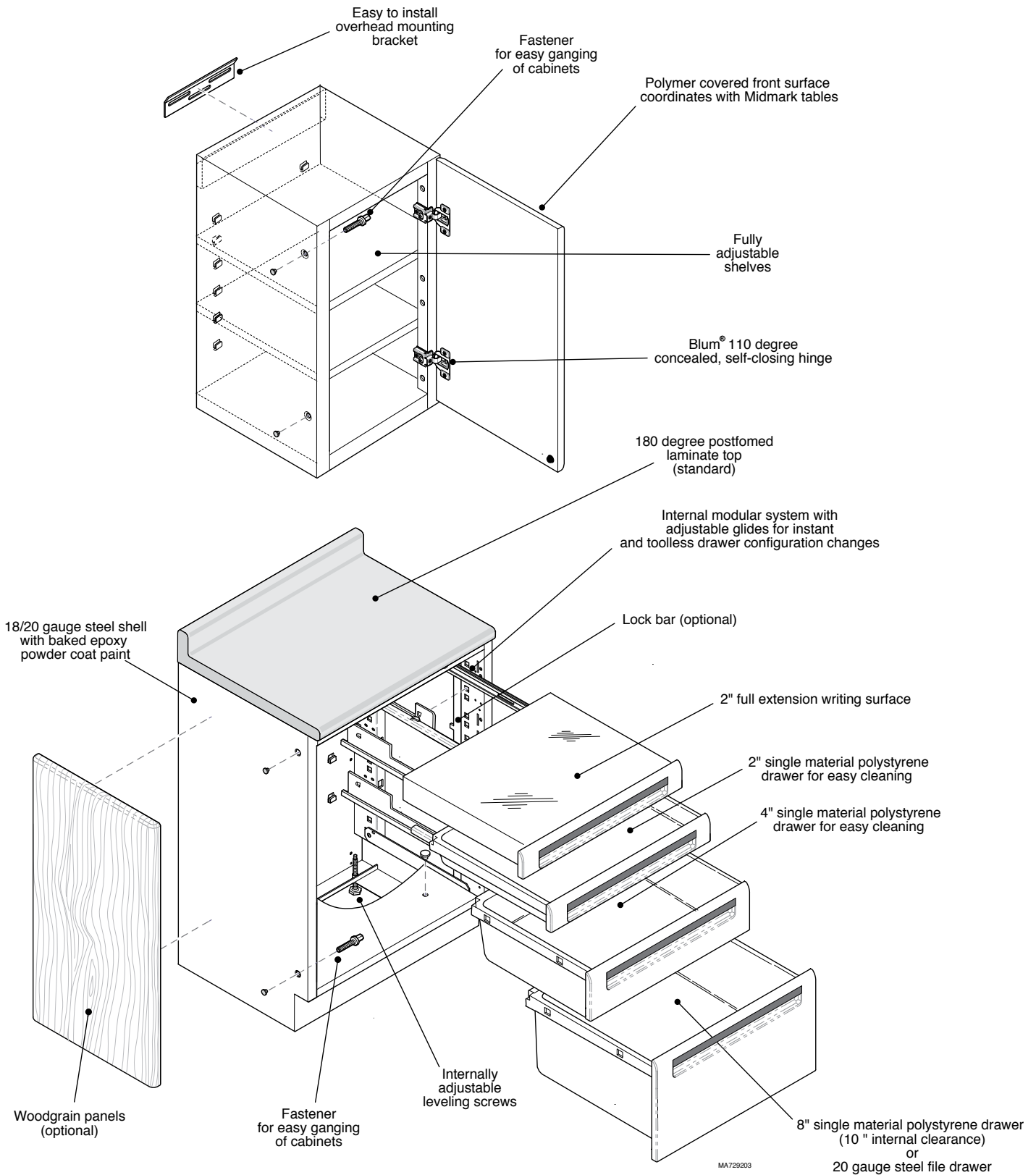

## MIDMARK CASEWORK SERIES

Finish/Color: Premium quality powder coat, baked-on epoxy. Base Color: Midmark Pebble Grey.

Casework Assembly:

Design: Individual, interchangeable, integral, modular units comprising a desired assembly

Cabinet: 18 and 20 gauge cold rolled steel; single-piece shell and bottom frame design; press joined (Tog-L-Loc®)

Filler and Trim: Manufacturer's standard coordinated components

Drawers:

Deep Drawer Construction: One piece molded polystyrene drawer bodies with rounded corners; manufacturer's color coordinated with cabinet color

File Drawer Construction: 20 gauge cold rolled steel frame; including suspended file system and file bars

Front/Back: 12 Mil. seamless polymer-covered front; melamine back

Core: 45 lb. MDF board, 3/4 thick

Slide: Manufacturer's standard 88 lb. capacity and heavy duty 150 lb. capacity slide for file drawers and pull-out waste units.

Pulls: Recessed and integrated front panel design; clear snap-on handle with interchangeable color strips, and optional labeling system

Door Construction:

Front/Back: 12 Mil. seamless polymer-covered front; melamine back

Core: 45 lb. MDF board, 3/4 thick

Hinges: Manufacturer's standard Blum®, concealed, self-closing, 110° opening, nickel plated metal

Pulls: Recessed and integrated front panel design; clear snap-on handle with interchangeable color strips, and optional labeling system

Adjustable Shelving: 20 gauge cold rolled steel, painted to match cabinet color; manufacturer's standard reinforced nylon support clips; 36" and wider shelves use 18 gauge cold rolled steel

Locks:

Doors: Manufacturer's standard Timberline, individually mounted, cam style lock or deadbolt orientation with removable lock plug; locks keyed alike with two keys per lock

Drawers: Manufacturer's standard Timberline lock body with removable lock plug with 14 gauge cold rolled steel pivoting lock bar for central lock system; locks keyed alike with two keys per lock.

Castors: Manufacturer's standard Gross Stabil®, 2" or 3" twin wheel design, stem mounting; locking; urethane wheel

Countertops: As described in "Top Schedule" indicated on drawings

Standard Countertops: Phenolic resign particle board core

Horizontal: High pressure laminate surfacing material is .045" thick, matte finish

Vertical: Melamine/Laminate, suede finish

Filler Panel/Leg Support: Particle board, 45 lb. – 48 lb. density

Plastic Laminate: Wilsonart™, Formica®; as selected

Solid Surface: Corian®

Accessories:

Plumbing Fixtures: Sinks: (as selected); Faucets: (as selected)

Task Lights: Light Corporation; Optional hard wiring or daisy chain system; Prismatic Acrylic lens; NPF ballast; UL Listed and CSA Certified; T8 cool white lamps; 18" and 36" length options

Project-Specific Specials: As indicated on drawings

# RITTER CABINET CUTAWAY

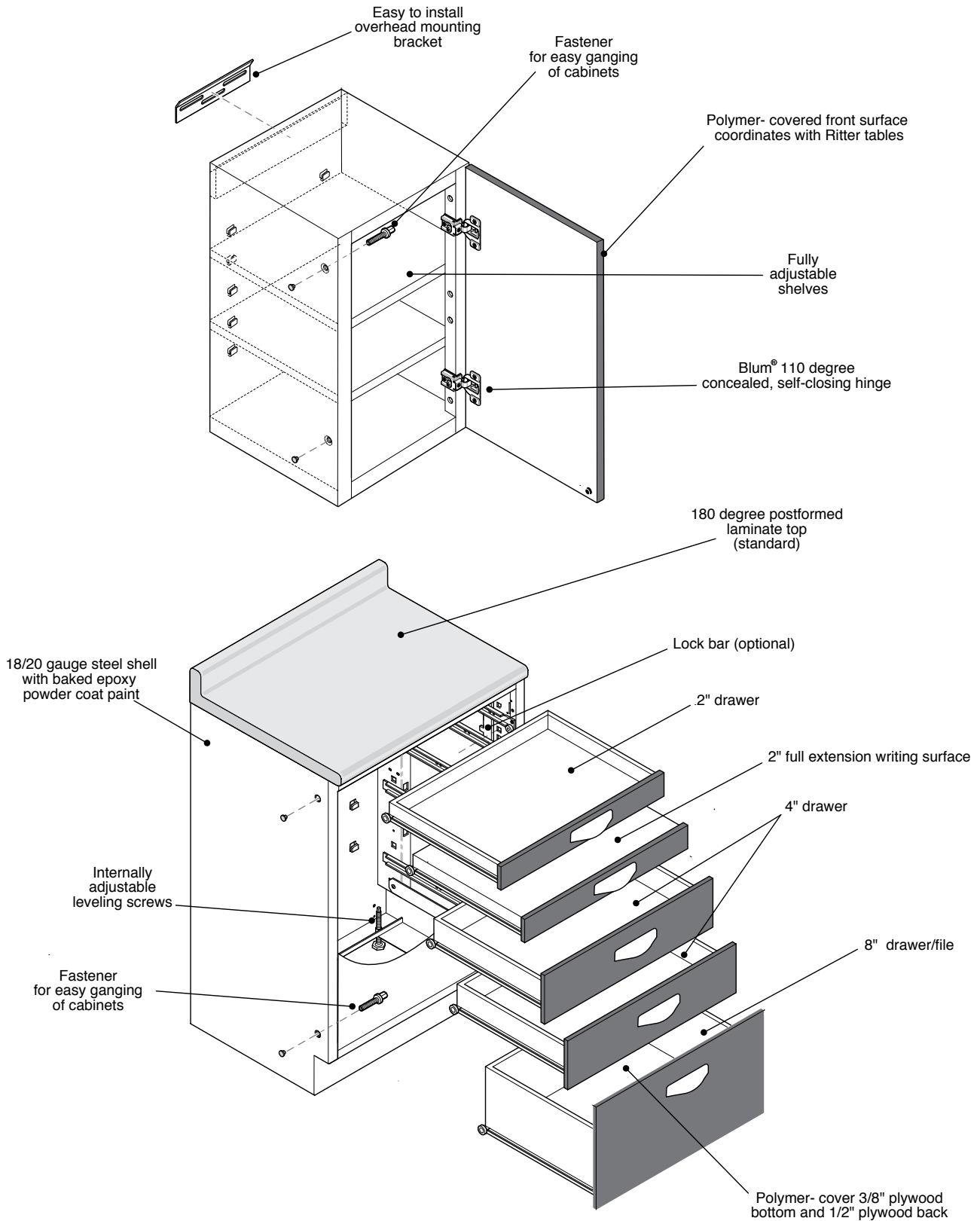

MA729302

## RITTER CASEWORK SERIES

Finish/Color: Premium quality powder coat, baked-on epoxy. Color: Pebble Grey

### Casework Assembly:

Design: Individual, modular units comprising a desired assembly

Cabinet: 18 and 20 gauge cold rolled steel; single-piece shell and bottom frame design; press joined (Tog-L-Loc®)

Filler and Trim: Manufacturer's standard coordinated components

Drawers: Steel, epoxy coated sides and runners; white plastic, noise absorbing, wear-free rollers; load capacity 100 lbs. (45 kg); 5/8" MDF board sides, polymer-covered coated, white; 1/4" MDF board bottom, melamine, white

File Drawer: Steel, epoxy coated sides and runners; white plastic, noise absorbing, wear-free rollers; load capacity 100 lbs. (45 kg); 5/8" MDF board sides, polymer-covered coated, white; 1/4" MDF board bottom, melamine, white 11 gauge cold rolled steel hanging folder frame for suspended file system and file bars.

Front: 12 Mil. seamless polymer-covered front: melamine back, 45lb. MDF board, 5/8" thick, custom laminate panel colors use 2 mm Pebble Grey PVC edge banding

Handle: Molded ABS, Pebble Grey color

### Door:

Front: 12 Mil. seamless polymer-covered front: melamine back, 45lb. MDF board, 5/8" thick, custom laminate panel colors use 2 mm Pebble Grey PVC edge banding

Hinges: Manufacturer's standard Blum®, concealed, self-closing, 110° opening, nickel plated metal

Handle: Molded ABS, Pebble Grey color

Adjustable Shelving: 20 gauge cold rolled steel, painted to match cabinet color; manufacturer's standard reinforced nylon support clips; 36" and wider cabinets use 18 gauge cold rolled steel

### Locks:

Doors: Manufacturer's standard Timberline, individually mounted, cam style or deadbolt lock orientation with removable lock plug; locks keyed alike with two keys per lock

Drawers: Manufacturer's standard Timberline lock body with removable lock plug with 14 gauge cold rolled steel pivoting lock bar for central lock system; locks keyed alike with two keys per lock

Casters: Manufacturer's standard Gross Stabil®, light duty, 2" or 3" twin wheel design, stem mounting, locking; urethane wheel

Countertops: As described in "Top Schedule" indicated on drawings

Standard Countertops: Phenolic resin particle board core

Horizontal: High pressure laminate surfacing material is .045" thick, matte finish

Vertical: Melamine, suede finish

Filler Panel/Leg Support: Particle board, 45 lb. – 48 lb. density

Plastic Laminate: Wilsonart™, Formica®, as selected

Solid Surface: Corian®

### Accessories:

Plumbing Fixtures: Sinks: (as selected); Faucets: (as selected)

Task Lights: Light Corporation; Optional hard wiring or daisy chain system; Prismatic Acrylic lens; NPF ballast; UL Listed and CSA Certified; T8 cool white lamps; 18" and 36" length options

Project-Specific Specials: As indicated on drawings

## TEST DATA SHEET

Chemical Resistance of finish, acid, solvents, bases and salts

### Description

1. Cabinet Base / Shelf / Steel Drawers
2. Drawer & Door Front (Midmark/Ritter)
3. Drawer & Door Pull (Midmark)
4. Drawer & Door Handle (Ritter)
5. Drawer (Midmark)

### Material Tested

- Paint  
 Polymer-covered Front  
 Polystyrene  
 ABS  
 Polystyrene

Testing of these parts consisted of soaking a 1/2" x 1/2" specimen in the chemicals for a period of one hour. The specimens were then removed from the chemical bath, rinsed with cold water and washed with detergent and warm water at 150° F (65° C). Surfaces of the samples were then examined under 100 foot candles of illumination for changes in gloss or softening of film.

<u>#</u>	<u>Solution</u>	<u>(1)</u>	<u>(2)</u>	<u>(3)</u>	<u>(4)</u>	<u>(5)</u>
1.	37% Hydrochloric Acid	A	A	A	A	A
2.	20% Hydrochloric Acid	A	A	A	A	A
3.	10% Hydrochloric Acid	A	A	A	A	A
4.	70% Sulfuric Acid	A	A	A	A	A
5.	25% Sulfuric Acid	A	A	A	A	A
6.	30% Nitric Acid	A	A	A	A	A
7.	10% Nitric Acid	A	A	A	A	A
8.	75% Phosphoric Acid	A	A	A	A	A
9.	25% Phosphoric Acid	A	A	A	A	A
10.	98% Acetic Acid	B	A	A	C	A
11.	50% Acetic Acid	A	A	A	A	A
12.	Ethyl Alcohol	B	A	A	A	A
13.	Butyl Alcohol	A	A	A	A	A
14.	Methyl Alcohol	A	A	A	A	A
15.	Ethyl Acetate	B	A	A	D	D
16.	Ethyl Ether	B	A	A	C	D
17.	MEK	B	A	A	D	D
18.	Toluene	A	A	A	C	D
19.	Acetone	B	A	A	D	C
20.	Benzene	A	A	A	C	D
21.	Carbon Tet	A	A	A	B	D
22.	37% Formaldehyde	A	A	A	B	C
23.	Gasoline	A	A	A	B	C
24.	Naphtha	A	A	A	A	B
25.	Kerosene	A	A	A	A	B
26.	Xylene	B	A	A	B	D
27.	Glycerin	A	A	A	B	C
28.	Furfural	B	B	A	C	C
29.	40% Sodium Hydroxide	A	A	A	A	A
30.	10% Sodium Hydroxide	A	A	A	A	A
31.	28% Amm. Hydroxide	A	A	A	A	A
32.	40% Pot. Hydroxide	A	A	A	A	A
33.	10% Pot. Hydroxide	A	A	A	A	A

#	Solution	(1)	(2)	(3)	(4)	(5)
34.	Sat. Zinc Chloride	A	A	A	A	A
35.	Sat. Sodium Chloride	A	A	A	A	A
36.	Sat. Sodium Sulfide	A	A	A	A	A
37.	Sat. Sodium Carbonate	A	A	A	A	A
38.	88% Formic Acid	N/A	N/A	A	C	A
39.	5% Hydrogen Peroxide	N/A	N/A	A	A	A
40.	Common Bleach	A	N/A	A	A	A

### **Key**

- A. No change in gloss, discoloration or softening of surface.
- B. Slight discoloration, change in gloss or temporary softening of surface.
- C. Definite change in gloss, discoloration, or softening of surface resulting in permanent distortion of original appearance.
- D. Severe attack on surface.

### **ADHESION AND FLEXIBILITY**

Three samples were subjected to the ASTM B3359-93, method B, cross cut tape (adhesion) test. The samples were scribed with two sets of eleven parallel lines which were 1 mm apart and which intersect each other at 90°, thus forming a grid of 100 squares. Each scribe line was deep enough to cut completely through the coating. The resulting area was then brushed lightly with a soft brush, checked for depth of cuts, and then the area had tape applied which met the ASTM requirement. The tape was seated using a pencil eraser and then pulled off at an angle as close to 180° as possible. The grid area was then examined and rated according to ASTM 3359-93, par. 12.9. This procedure was repeated in two other locations on each sample.

Tape adhesion rating of 5B (no paint removed)

### **HARDNESS**

Three samples were subjected to the ASTM D3363-92a, Film Harness by Pencil Test. Pencil leads, honed to a circular diameter, were pushed across the surface of each sample at a 45 angle using enough pressure to crumble the lead. The distance of the resulting mark was a minimum of .25 inches. The pencil lead push test was repeated, starting with 5H lead, with successfully softer lead, until the surface was (1) not gouged and (2) not scratched. The pencil hardness at which each condition was observed is reported in the test data.

Gouge rating of 2H

Scratch rating of F

### **CLEANING**

Regular care should be maintained by wiping with a damp cloth or sponge, using mild soap and water solution. The drawer may also be removed for cleaning.

### **QUESTIONS**

Please call Midmark Casework Customer Service at 1-800-643-6275 ext. 8914 for assistance.

## MIDMARK MODULAR CASEWORK ORDER POLICY

### ORDER POLICY FOR STANDARD PRODUCT

- At least five weeks prior to “Ship Week”, the order/purchase order must be in the system.
- One week after order/purchase order is received, the Customer Acknowledgment is sent to customer.
- Three weeks prior to “Ship Week”, is the “No Charge Change Deadline”.
- Two weeks prior to “Ship Week”, is the “Charged Changes Deadline”.
- One week prior to “Ship Week”, no changes are allowed.

TYPICAL ORDER/CHANGE SCHEDULE

30	31	1	2	3	4	5
<b>ORDER RECEIVED</b>						
6	7	8	9	10	11	12
<b>CUSTOMER ACKNOWLEDGMENT</b>						
13	14	15	16	17	18	19
<b>NO CHARGE CHANGES</b>						
20	21	22	23	24	25	26
<b>CHARGED CHANGES</b>						
27	28	29	30	31	1	2
<b>NO CHANGE</b>						
3	4	5	6	7	8	9
<b>SHIP WEEK</b>						

Requests for changes during the charge week or no change week in shipping dates, changes to the order, cancelling product from an order, changes of destination address, packaging, and method of delivery may delay the ship date or incur additional costs, and are subject to approval by Midmark. Charges will be incurred for all line items that change as noted in this paragraph. These are our typical lead times. Please call to confirm current lead times.

### ORDER POLICY FOR SPECIAL COLORS ON COUNTERTOPS, CORIAN SURFACE COUNTERTOPS, AND/OR RITTER PANELS

- At least six weeks prior to “Ship Week”, the order/purchase order must be in the system.
- One week after order/purchase order is received, the Customer Acknowledgment is sent to customer.
- Five weeks prior to “Ship Week”, is the “No Charge Change Deadline”.
- Four weeks prior to “Ship Week”, is the “Charged Changes Deadline”.
- Three weeks prior to “Ship Week”, no changes are allowed.

TYPICAL ORDER/CHANGE SCHEDULE

30	31	1	2	3	4	5
<b>ORDER RECEIVED</b>						
6	7	8	9	10	11	12
<b>CUSTOMER ACKNOWLEDGMENT</b>						
13	14	15	16	17	18	19
<b>NO CHARGE CHANGES</b>						
20	21	22	23	24	25	26
<b>CHARGED CHANGES</b>						
27	28	29	30	31	1	2
<b>NO CHANGE</b>						
3	4	5	6	7	8	9
<b>NO CHANGE</b>						
10	11	12	13	14	15	16
<b>SHIP WEEK</b>						

Requests for changes during the charge week or no change week in shipping dates, changes to the order, canceling product from an order, changes of destination address, packaging, and method of delivery may delay the ship date or incur additional costs, and are subject to approval by Midmark. Charges will be incurred for all line items that change as noted in this paragraph. These are our typical lead times. Please call to confirm current lead times.

## SHIPPING POLICY

- First project shipment, over \$16,000 suggested retail price, **Versailles, OH, F.O.B., Freight Paid** Additional deliveries to a single project are not included in Midmark's freight policy.
- Additional deliveries, **Versailles, OH, F.O.B., Prepaid & Add**  
Please call your Project Coordinator for shipping quotes at **1-800-MIDMARK**, ext. 8914.
- Projects less than \$16,000 suggested retail price, Versailles, OH, F.O.B., Prepaid & Add  
Please call your Project Coordinator for shipping quotes at **1-800-MIDMARK**, ext. 8914.
- Policy excludes shipments outside the Continental U.S.

*Note: Delivery times will not be guaranteed by Midmark Corporation.  
National carriers do not guarantee time of arrival.*

## MODULAR CASEWORK LIMITED WARRANTY

### SCOPE OF WARRANTY

Midmark Corporation warrants to the original purchaser its Midmark Modular Casework products manufactured by Midmark to be free from defects in material and workmanship under normal interior use and service. Midmark's obligation under this warranty is limited to the repair or replacement, at Midmark's option, of the parts or the products the defects of which are reported to Midmark within the applicable warranty period and which upon examination by Midmark prove to be defective.

### APPLICABLE WARRANTY PERIOD

The applicable warranty period, measured from the date of delivery to the original user, shall be as follows:

- A. Five years for all Midmark brand products and components (except for the shorter periods in B, C and D), including door and drawer fronts, casters and electrical components such as task lights and cords.
- B. Three years for all Ritter brand products and components.
- C. Three years for task light ballast.
- D. One year for countertop surfaces and accessories.

### EXCLUSIONS

This warranty does not cover sinks, faucets and plumbing accessories. Any warranties on these items are extended directly by the manufacturer of these items to the original purchaser. Information on these manufacturers' warranties will be enclosed with the applicable products. Also, Midmark will furnish copies of any warranties extended by any such manufacturers upon request.

This warranty does not cover and Midmark shall not be liable for: (1) repairs and replacements required because of misuse, abuse, negligence, alteration, accident, freight damage or tampering; (2) matching of color, grain or texture except to commercially acceptable standards; (3) changes in color caused by natural or artificial light; (4) products which are not installed, used or properly cleaned as required in Midmark's written Installation Manual; (5) specially manufactured products; (6) products considered to be of a consumable nature such as light bulbs and surge suppression products; (7) accessories or parts not manufactured by Midmark; (8) charges by anyone (including Midmark's authorized dealers) for adjustments, repairs, replacement parts, installation or other work performed upon or in connection with such products which is not expressly authorized in writing in advance by Midmark.

### EXCLUSIVE REMEDY

Midmark's only obligation under this warranty is the repair or replacement of defective parts. Midmark shall not be liable for any direct, special, indirect, incidental, exemplary or consequential damages or delay.

### NO AUTHORIZATION

No person or firm is authorized to create for Midmark any other obligation or liability in connection with the products.

**THIS WARRANTY IS MIDMARK'S ONLY WARRANTY AND IS IN LIEU OF ALL OTHER WARRANTIES, EXPRESSED OR IMPLIED. MIDMARK MAKES NO IMPLIED WARRANTIES OF ANY KIND INCLUDING ANY WARRANTIES OF MERCHANTABILITY OR FITNESS FOR ANY PARTICULAR PURPOSE. THIS WARRANTY IS LIMITED TO THE REPAIR OR REPLACEMENT OF DEFECTIVE PARTS.**

### 36" HIGH BASE EXAM – SINK/STORAGE COMBINATION UNITS

Drawing	Configuration	Description	Widths	Depths
	SBZ014	Base Exam Room, RH Sink, LH 1—4" Drawer, 1 Door LH	30, 36, 42, 48	18, 24
	SBZ015	Base Exam Room, LH Sink, RH 1—4" Drawer, 1 Door RH	30, 36, 42, 48	18, 24
	SBZ016	Base Exam Room, RH Sink, LH 2—4" Drawers, 1 Door LH	30, 36, 42, 48	18, 24
	SBZ017	Base Exam Room, LH Sink, RH 2—4" Drawers, 1 Door RH	30, 36, 42, 48	18, 24
	SBZ018	Base Exam Room, RH Sink, LH 3—4" Drawers, 1—8" Drawers	30, 36, 42, 48	18, 24

### 36" HIGH BASE EXAM – SINK/STORAGE COMBINATION UNITS

Drawing	Configuration	Description	Widths	Depths
	SBZ019	Base Exam Room, LH Sink, RH 3—4" Drawers, 1—8" Drawers	30, 36, 42, 48	18, 24
	SBZ020	Base Exam Room, RH Sink, LH 5—4" Drawers	30, 36, 42, 48	18, 24
	SBZ021	Base Exam Room, LH Sink, RH 5—4" Drawers	30, 36, 42, 48	18, 24
	SBZ029	Sink Base, 1 Door RH LH 1 Writing Surface 1—2" Drawer, 1 Door LH	48	18, 24
	SBZ030	Base Exam Room, LH Sink, RH 1 Writing Surface, 1—2" Drawer, 1 Door RH	48	18, 24

### 36" HIGH BASE EXAM – SINK/STORAGE COMBINATION UNITS

Drawing	Configuration	Description	Widths	Depths
	SBZ031	Base Exam Room, RH Sink, LH 1 Writing Surface, 1—2", 1—4" Drawer, 1 Door LH	48	18, 24
	SBZ032	Base Exam Room, LH Sink, RH 1 Writing Surface, 1—2", 1—4" Drawer, 1 Door RH	48	18, 24
	SBZ033	Base Exam Room, RH Sink, LH 1 Writing Surface, 1—2", 2—4", 1—8" Drawer	48	18, 24
	SBZ034	Base Exam Room, LH Sink, RH 1 Writing Surface, 1—2", 2—4", 1—8" Drawer	48	18, 24
	SBZ037 (Midmark Only)	Base Steri-Center, 1 Writing Surface, 1 Wrapping, 1—4" Drawer, 2 Doors	24, 30	24

### 36" HIGH BASE EXAM – SINK/STORAGE COMBINATION UNITS

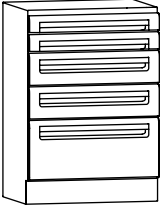
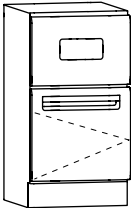
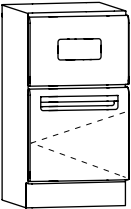
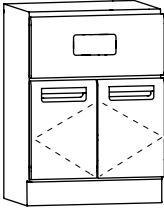
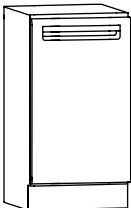
Drawing	Configuration	Description	Widths	Depths
	SBZ038 (Midmark Only)	Base Steri-Center, 1 Writing Surface, 1 Wrapping, 2—4", 1—8" Drawer	24, 30	24
	SBZ039R	Base Steri-Center, Ultrasonic, 1 Ultrasonic Control Panel, 1 Door RH	18, 24	24
	SBZ039L	Base Steri-Center, Ultrasonic, 1 Ultrasonic Control Panel, 1 Door LH	18, 24	24
	SBZ040	Base Steri-Center, Ultrasonic, 1 Ultrasonic Control Panel, 2 Doors	30	24
	SBZ041	Base, Pull-out Waste	15, 18	18, 24

### 36" HIGH BASE SINK UNITS

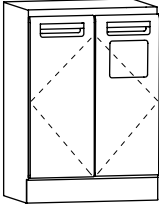
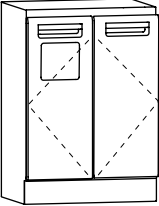
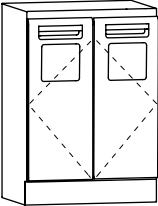
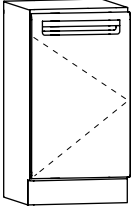
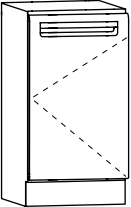
Drawing	Configuration	Description	Widths	Depths
	SBS001	Sink Base, 2 Doors, w/RH Waste Drop	24, 30, 36	18, 24
	SBS002	Sink Base, 2 Doors, w/LH Waste Drop	24, 30, 36	18, 24
	SBS003	Sink Base, 2 Doors, Double Waste Drop	24, 30, 36	18, 24
	SBS004R	Sink Base, 1 Door RH	18, 21, 24	18, 24
	SBS004L	Sink Base, 1 Door LH	18, 21, 24	18, 24

## 36" HIGH BASE SINK UNITS

Drawing	Configuration	Description	Widths	Depths
	SBS005	Sink Base, 2 Doors	24, 30, 36	18, 24
	SBS009	Sink Base, 2 Doors, w/TapMaster Foot Control	24, 30, 36	18, 24
	SBS010	Sink Base, 2 Doors, w/RH Waste Drop & TapMaster Foot Control	24, 30, 36	18, 24
	SBS011	Sink Base, 2 Doors, w/LH Waste Drop & TapMaster Foot Control	24, 30, 36	18, 24
	SBS012R	Sink Base, 1 Door RH w/TapMaster Foot Control	18, 21, 24	18, 24

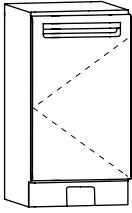
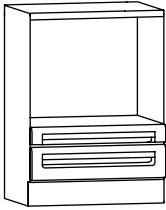

**36" HIGH BASE SINK UNITS**

Drawing	Configuration	Description	Widths	Depths
	SBS012L	Sink Base, 1 Door LH w/TapMaster Foot Control	18, 21, 24	18, 24
	SBS045 (Midmark Only)	Sink Base, 1 Writing Surface 1-4" Drawer (Hydrim Cabinet)	24, 30	24

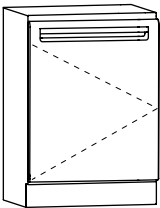
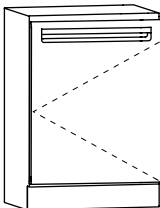
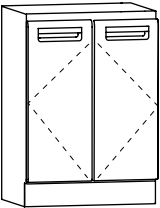
**30" HIGH BASE SINK UNITS**

Drawing	Configuration	Description	Widths	Depths
	SBS020R	Sink Base, 1 Door, RH	18, 21, 24	18, 24
	SBS020L	Sink Base, 1 Door, LH	18, 21, 24	18, 24
	SBS021	Sink Base, 2 Doors	24, 30, 36	18, 24

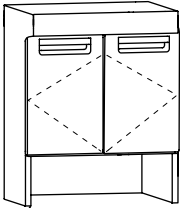
## 34" HIGH BASE SINK UNITS

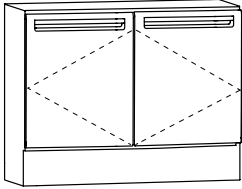
Drawing	Configuration	Description	Widths	Depths
	SBS030	Sink Base, 2 Doors  <i>Meets Americans with Disabilities Act (ADA) Requirements</i>	36	24
	SBS031	Sink Base, 2 Doors	24, 30, 36	18, 24

## 36" HIGH BASE STORAGE UNITS

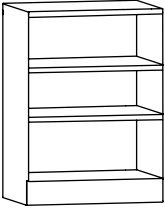
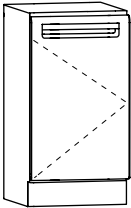
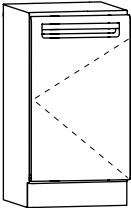
Drawing	Configuration	Description	Widths	Depths
	SBP001	Base Storage, No Doors	12, 15, 18, 21, 24, 30, 36, 42, 48	18, 24
	SBP006R	Base Storage, 1 Door RH	12, 15, 18, 21, 24	18, 24
	SBP006L	Base Storage, 1 Door LH	12, 15, 18, 21, 24	18, 24

## 36" HIGH BASE STORAGE UNITS

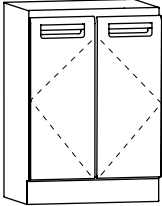
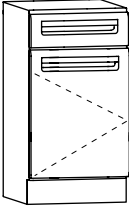
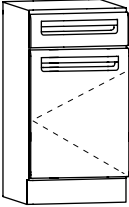
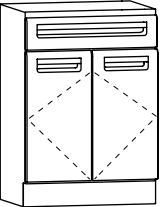
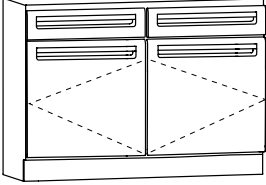
Drawing	Configuration	Description	Widths	Depths
	SBP007	Base Storage, 2 Doors	24, 30, 36, 42,	18, 24 48
	SBP012R	Base Storage, 1—4" Drawer, 1 Door RH	12, 15, 18, 21, 24	18, 24
	SBP012L	Base Storage, 1—4" Drawer, 1 Door LH	12, 15, 18, 21, 24	18, 24
	SBP013	Base Storage, 1—4" Drawer, 2 Doors	24, 30, 36	18, 24
	SBP014	Base Combination, 2—4" Drawers, 2 Doors	42, 48	18, 24

## 36" HIGH BASE STORAGE UNITS

Drawing	Configuration	Description	Widths	Depths
	SBP015	Base Storage, 2—2" Drawers, 2 Doors	24, 30	18, 24
	SBP019R	Base Storage, 2—4" Drawers, 1 Door, RH	12, 15, 18, 21 24	18, 24
	SBP019L	Base Storage, 2—4" Drawers, 1 Door, LH	12, 15, 18, 21 24	18, 24
	SBP020	Base Storage, 2—4" Drawers, 2 Doors	24, 30, 36	18, 24
	SBP021	Base Combination, 4—4" Drawers, 2 Doors	42, 48	18, 24

## 36" HIGH BASE STORAGE UNITS

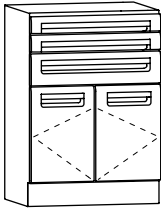
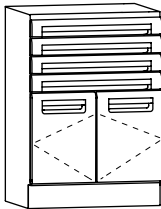
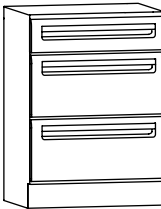
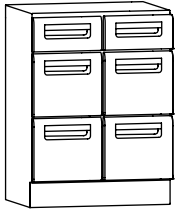
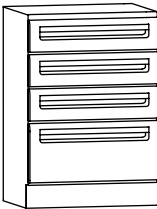
Drawing	Configuration	Description	Widths	Depths
	SBP022	Base Storage, 2—2", 1—4" Drawers, 2 Doors	24, 30	18, 24
	SBP023	Base Storage, 4—2" Drawers, 2 Doors	24, 30	18, 24
	SBP024	Base Storage, 1—4", 2—8" Drawers	12, 15, 18, 21 24, 30, 36	18, 24
	SBP025	Base Combination, 2—4", 4—8" Drawers	30, 36, 42, 48	18, 24
	SBP027	Base Storage, 3—4", 1—8" Drawers	12, 15, 18, 21 24, 30, 36	18, 24

## 36" HIGH BASE STORAGE UNITS

Drawing	Configuration	Description	Widths	Depths
	SBP029	Base Storage, 2—2", 2—4", 1—8" Drawers	24, 30	18, 24
	SBP032	Base Storage, 5—4" Drawers	12, 15, 18, 21 24, 30, 36	18, 24
	SBP033	Base Combination, 10—4" Drawers	30, 36, 42, 48	18, 24
	SBP034	Base Storage, 2—2", 4—4" Drawers	24, 30	18, 24
	SBP035	Base Storage, 4—2", 3—4" Drawers	24, 30	18, 24

**36" HIGH BASE STORAGE UNITS**

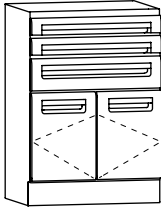
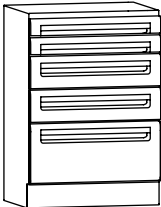
Drawing	Configuration	Description	Widths	Depths
	SBP039	Base Storage, 1 Writing Surface, 1—2", 1—4" Drawers, 2 Doors	24, 30	18, 24
	SBP040	Base Storage, 1 Writing Surface, 1—2", 2—4", 1—8" Drawers	24, 30	18, 24

**34" HIGH BASE STORAGE UNITS**

Matches ADA & 34" High Sink

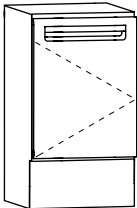
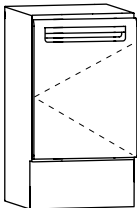
Drawing	Configuration	Description	Widths	Depths
	SBP113R	Base Storage, 1 Door RH	18, 24	18, 24
	SBP113L	Base Storage, 1 Door LH	18, 24	18, 24

## 34" HIGH BASE STORAGE UNITS

Matches ADA & 34" High Sink

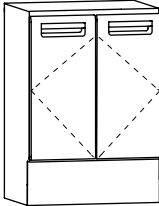
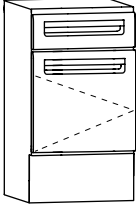
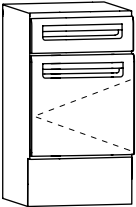
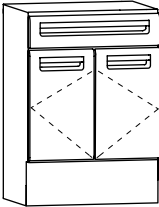
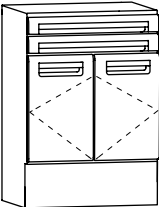
Drawing	Configuration	Description	Widths	Depths
	SBP114	Base Storage, 2 Doors	24, 30	18, 24
	SBP117R	Base Storage, 1—4" Drawer, 1 Door RH	18, 24	18, 24
	SBP117L	Base Storage, 1—4" Drawer, 1 Door LH	18, 24	18, 24
	SBP118	Base Storage, 1—4" Drawer, 2 Doors	24, 30	18, 24
	SBP119	Base Storage, 2—2" Drawers, 2 Doors	24, 30	18, 24

## 34" HIGH BASE STORAGE UNITS

Matches ADA & 34" High Sink

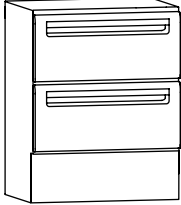
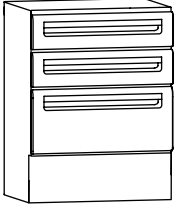
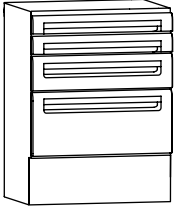
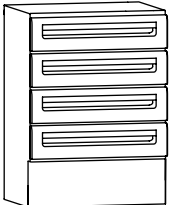
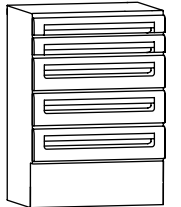
Drawing	Configuration	Description	Widths	Depths
	SBP120	Base Storage, 2—10" Drawers,	18, 24, 30	18, 24
	SBP121	Base Storage, 2—4", 1—8" Drawers,	18, 24, 30	18, 24
	SBP122	Base Storage, 2—2", 1—4", 1—8" Drawers	24, 30	18, 24
	SBP124	Base Storage, 4—4" Drawers	18, 24, 30	18, 24
	SBP125	Base Storage, 2—2", 3—4" Drawers	24, 30	18, 24

## 30" HIGH BASE STORAGE UNITS

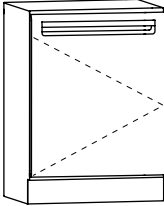
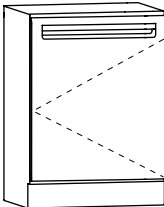
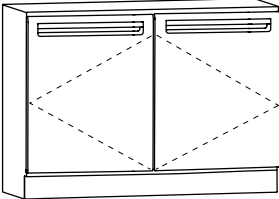
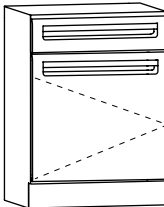
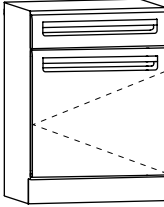
Drawing	Configuration	Description	Widths	Depths
	SBP065R	Base Storage, 1 Door RH	12, 15, 18, 21 24	18, 24
	SBP065L	Base Storage, 1 Door LH	12, 15, 18, 21 24	18, 24
	SBP066	Base Storage, 2 Doors	24, 30, 36, 42 48	18, 24
	SBP071R	Base Storage, 1—4" Drawer, 1 Door RH	12, 15, 18, 21 24	18, 24
	SBP071L	Base Storage, 1—4" Drawer, 1 Door LH	12, 15, 18, 21 24	18, 24

### 30" HIGH BASE STORAGE UNITS

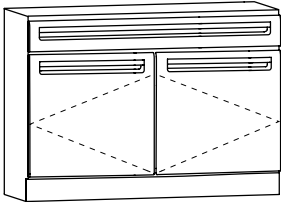
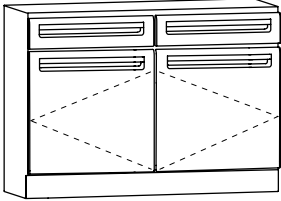
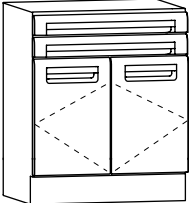
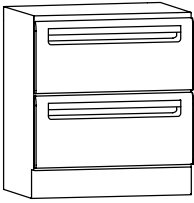
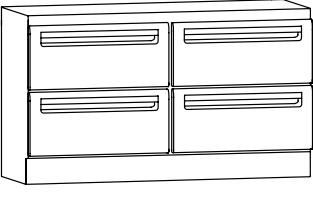
Drawing	Configuration	Description	Widths	Depths
	SBP072	Base Storage, 1—4" Drawer, 2 Doors	24, 30, 36	18, 24
	SBP073	Base Combination, 2—4" Drawer, 2 Doors	42, 48	18, 24
	SBP074	Base Storage, 2—2" Drawer, 2 Doors	24, 30	18, 24
	SBP075	Base Storage, 2—8" Drawers	12, 15, 18, 21 24, 30, 36	18, 24
	SBP076	Base Combination, 4—8" Drawers	30, 36, 42, 48	18, 24

## 30" HIGH BASE STORAGE UNITS

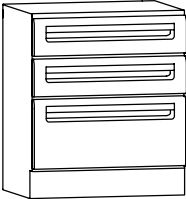
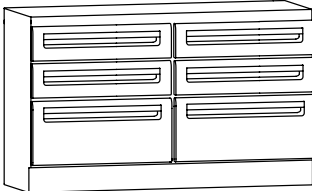
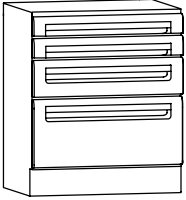
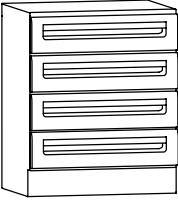
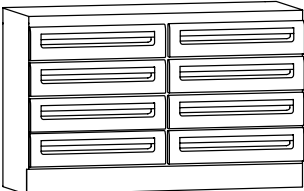
Drawing	Configuration	Description	Widths	Depths
	SBP077	Base Storage, 2—4", 1—8" Drawers	12, 15, 18, 21 24, 30, 36	18, 24
	SBP078	Base Combination, 4—4", 2—8" Drawers	30, 36, 42, 48	18, 24
	SBP079	Base Storage, 2—2", 1—4", 1—8" Drawers	24, 30	18, 24
	SBP081	Base Storage, 4—4" Drawers	12, 15, 18, 21 24, 30, 36	18, 24
	SBP082	Base Combination, 8—4" Drawers	30, 36, 42, 48	18, 24

**30" HIGH BASE STORAGE UNITS**

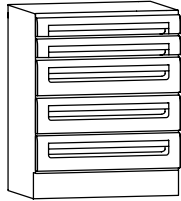
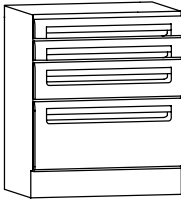
Drawing	Configuration	Description	Widths	Depths
	SBP083	Base Storage, 2—2", 3—4" Drawers	24, 30	18, 24
	SBP087	Base Storage, 1 Writing Surface, 1—2", 1—4", 1—8" Drawers	24, 30	18, 24

**36" HIGH BASE FILE UNITS**

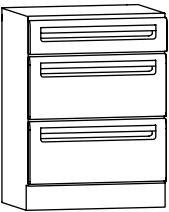
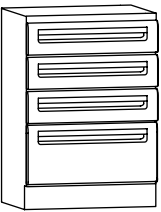
Drawing	Configuration	Description	Widths	Depths
	SBF001	Base File, 1—4" Drawer, 2 File Drawers	18, 21, 24, 30 36	18, 24
	SBF003	Base File, 3—4" Drawers, 1 File Drawer	18, 21, 24, 30 36	18, 24

\*Ritter File Units only available in 18", 21" and 24" widths

### 36" HIGH BASE FILE UNITS

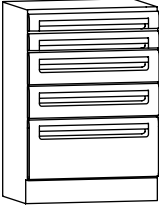
Drawing	Configuration	Description	Widths	Depths
	SBF005	Base File, 1 Writing Surface, 1—2", 2—4" Drawers, 1 File Drawer	24, 30	18, 24

\*Ritter File Units only available in 18", 21" and 24" widths

### 30" HIGH BASE FILE UNITS

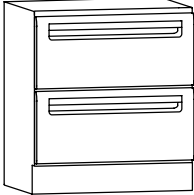
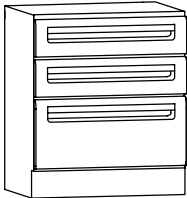
Drawing	Configuration	Description	Widths	Depths
	SBF015	Base File, 2 File Drawers	18, 21, 24, 30 36	18, 24
	SBF017	Base File, 2—4" Drawers, 1 File Drawer	18, 21, 24, 30 36	18, 24

\*Ritter File Units only available in 18", 21" and 24" widths

**34" HIGH BASE FILE UNITS**

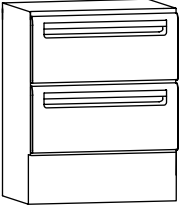
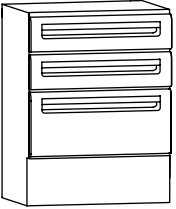
Drawing	Configuration	Description	Widths	Depths
	SBF030	Base File, 2 File Drawers	18, 24, 30	18, 24
	SBF031	Base File, 2—4" Drawers, 1 File Drawer	18, 24, 30	18, 24

\*Ritter File Units only available in 18" and 24" widths

**36" HIGH BASE CORNER UNITS**

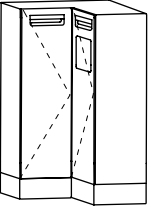
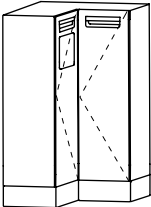
Drawing	Configuration	Description	Widths	Depths
	SBC001R	Base Corner, 90° 1 Bi-fold Door RH w/RH Waste,	30 36	18 24
	SBC002L	Base Corner, 90° 1 Bi-fold Door LH w/LH Waste, Base Sink	30 36	18 24

## 36" HIGH BASE CORNER UNITS

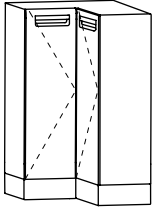
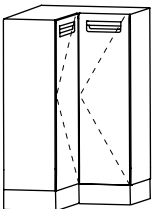
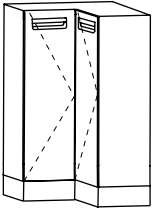
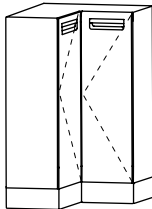
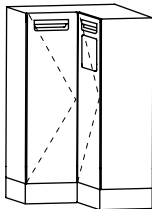
Drawing	Configuration	Description	Widths	Depths
	SBC004R	Base Corner, 90° 1 Bi-fold Door RH, Base Sink	30 36	18 24
	SBC004L	Base Corner, 90° 1 Bi-fold Door LH, Base Sink	30 36	18 24
	SBC010R	Base Corner, 90° 1 Bi-fold Door RH, Base Storage	30 36	18 24
	SBC010L	Base Corner, 90° 1 Bi-fold Door LH, Base Storage	30 36	18 24
	SBC014R	Base Corner, 90° 1 Bi-fold Door RH w/RH Waste, Base Storage	30 36	18 24

### 36" HIGH BASE CORNER UNITS

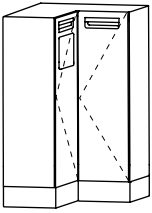
Drawing	Configuration	Description	Widths	Depths
	SBC015L	Base Corner, 90° 1 Bi-fold Door LH w/LH Waste, Base Storage	30 36	18 24

### 30" HIGH BASE CORNER UNITS

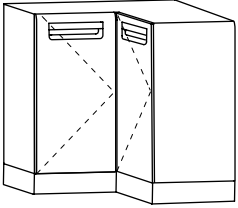
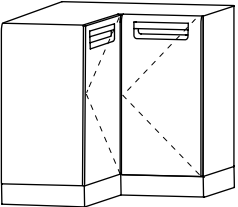
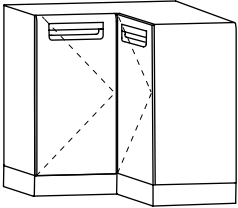
Drawing	Configuration	Description	Widths	Depths
	SBC020R	Base Corner, 90° 1 Bi-fold Door RH, Base Sink	30 36	18 24
	SBC020L	Base Corner, 90° 1 Bi-fold Door LH, Base Sink	30 36	18 24
	SBC025R	Base Corner, 90° 1 Bi-fold Door RH, Base Storage	30 36	18 24



### 30" HIGH BASE CORNER UNITS

Drawing	Configuration	Description	Widths	Depths
	SBC025L	Base Corner, 90° 1 Bi-fold Door LH, Base Storage	30 36	18 24

### 34" HIGH BASE CORNER UNITS

Drawing	Configuration	Description	Widths	Depths
	SBC035R	Base Corner, 90° 1 Bi-fold Door RH, Base Storage	30 36	18 24
	SBC035L	Base Corner, 90° 1 Bi-fold Door LH, Base Storage	30 36	18 24

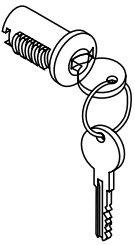
FLOOR BASE UNIT OPTIONS

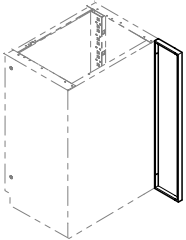
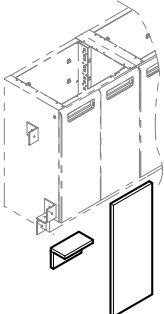

Drawing	Configuration	Description	Widths	Depths
		Locks	30, 34, 36	
	SBA001R	Metal End Scribe, RH	30, 34, 36	
	SBA001L	Metal End Scribe, LH	30, 34, 36	
	SBA004	Metal End Caps	30, 34, 36	6
	SBA003	6"W Filler Panel Kits  *To be cut to fit in the field.	30, 34, 36	

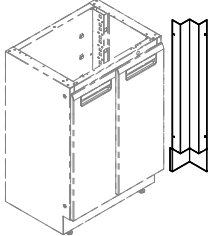
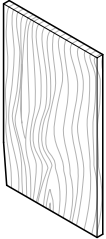
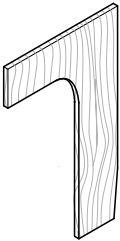
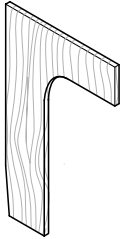
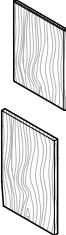
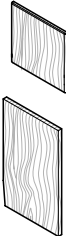
# FLOOR BASE UNIT OPTIONS

Drawing	Configuration	Description	Widths	Depths
	SBA002	Corner Brackets	30, 34, 36	
	SBA005 (Midmark Only)	Base End Panel - Wood Grain	30, 36	18, 24
	SBA006R (Midmark Only)	ADA End Panel, RH - Wood Grain	34	24
	SBA006L (Midmark Only)	ADA End Panel, LH - Wood Grain	34	24
	SBA007 (Midmark Only)	Drop-Down End Panel - Wood Grain (Used w/ Desk Unit)	36	18, 24
	SBA008 (Midmark Only)	Drop-Down End Panel - Wood Grain (Used w/ Countertop)	36	18, 24

NOTES

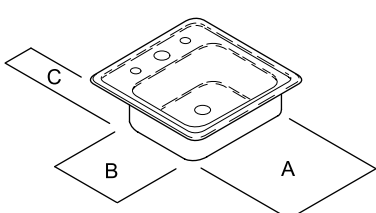
## SINKS - STAINLESS STEEL

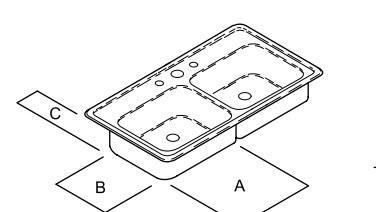
Drawing	Part Number	Outside Dimension W x D	Bowl Dimension A x B x C	Number of Facet Holes
 <p>SINGLE BOWL</p>	CSK-S121005-1	15" x 15"	12" x 10" x 5.12"	1
	CSK-S121005-2	15" x 15"	12" x 10" x 5.12"	2
	CSK-S121005-3	15" x 15"	12" x 10" x 5.12"	3
	CSK-S141406-3	17" x 19"	14" x 14" x 6.12"	3
	CSK-S181411-1	21" x 19"	18" x 14" x 10.5"	1
	CSK-S181411-2	21" x 19"	18" x 14" x 10.5"	2
	CSK-S181411-3	21" x 19"	18" x 14" x 10.5"	3
	CSK-S211605-3	25" x 21.5"	21" x 15.75" x 5.38"	3
	CSK-S211607-3 	25" x 21.5"	21" x 15.75" x 6.5"	3
 <p>DOUBLE BOWL</p>	CSK-D141605-3	33" x 21.5"	(2) 14" x 15.75" x 5.38"	3
	CSK-D141607-3	33" x 21.5"	(2) 14" x 15.75" x 7"	3
	CSK-D141611-3	33" x 21"	(2) 14" x 16" x 10.5"	3

## SINKS - UNDERMOUNT

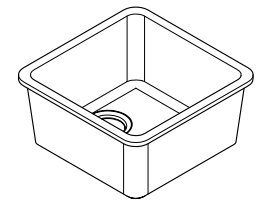
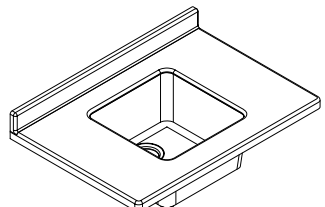

Drawing	Part Number	Outside Dimension W x D	Bowl Dimension A x B x C
	<u>Corian</u>		
	027-1303-00	14.44" x 12.38"	12.44" x 10.44" x 6.5"
	027-1303-01	17.5" x 17.5"	15.75" x 15.75" x 8.13"
	027-1303-02	12.38" x 14.44"	10.44" x 12.44" x 6.5"
	027-1303-03	31.25" x 18.94"	13.69" x 16.44" x 9"
	027-1303-04	19" x 15.13"	17.13" x 13.38" x 7.13"
	027-1303-05	22.94" x 17.69"	21" x 15.75" x 7.38"
	<u>Stainless</u>		
	027-1303-006	20" x 11"	18" x 14" x 10.5"

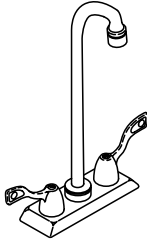
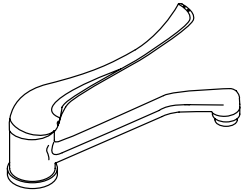
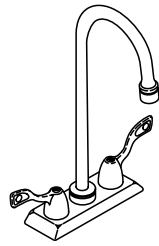
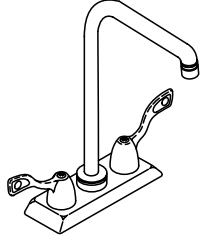
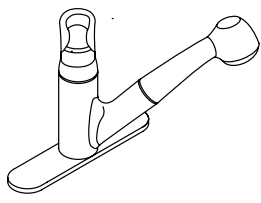
## FAUCETS

Drawing	Part Number	Description	Number of Facet Holes
	CFT-3GS4WB-2	3.5" Gooseneck, Wristblade Handle	2
	CFT-4ST4LV-1	Lever Handle	1
	CFT-6GS4WB-3	6" Gooseneck, Wristblade Handles	3
	CFT-9HR4WB-3	9" High-rise, Wristblade Handles	3
	CFT-CHPULL4LV-3 CFT-WHPULL4LV-3	Pullout Spout, Lever Handle (Chrome Finish) Pullout Spout, Lever Handle (White Finish)	1, 3 1, 3

SINK & FAUCET

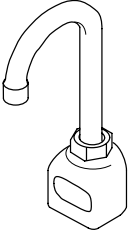
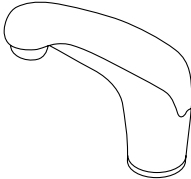
## FAUCETS

Drawing	Part Number	Description	Number of Facet Holes
	CFT-6GSELC-1	5 3/8" Gooseneck, Electronic	1
	CFT-6STELC-1	4 7/8" Electronic   <i>Meets Americans with Disabilities Act (ADA) Requirements</i>	1

**SINK ACCESSORIES**

Drawing	Part Number	Description
---------	-------------	-------------

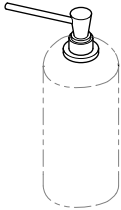

CPA-PMPDSP-1 Pump Dispenser, Chrome  
CPA-PMPDSPW-1 Pump Dispenser, White

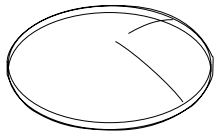

CPA-FCTHLCVR Faucet Hole Cover

**SINK & FAUCET**

**69" TALL STORAGE UNITS (Not Available in Ritter)**

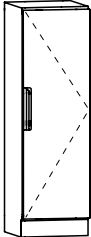
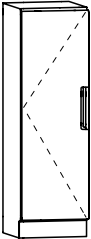
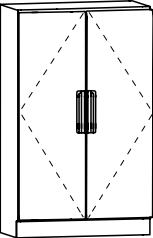
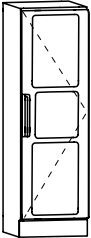
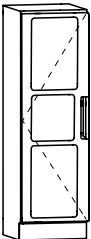
Drawing	Configuration	Description	Widths	Depths
	STP002R	Tall Storage Unit, w/RH Door	24	18, 24
	STP002L	Tall Storage Unit, w/LH Door	24	18, 24
	STP003	Tall Storage Unit, 2 Doors	30, 36	18, 24
	STP004R	Tall Storage Unit, w/RH Frame Plexi-glass Door	24	18, 24
	STP004L	Tall Storage Unit, w/LH Frame Plexi-glass Door	24	18, 24

## 69" TALL STORAGE UNITS (Not Available in Ritter)

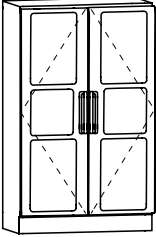
Drawing	Configuration	Description	Widths	Depths
	STP005	Tall Storage Unit, 2 Frame Plexi-glass Doors	30, 36	18, 24

## 84" TALL STORAGE UNIT

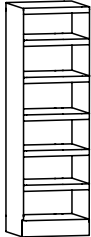
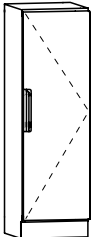
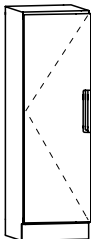
Drawing	Configuration	Description	Widths	Depths
	STP030	Tall Storage Unit, No Doors	12, 18, 24 30, 36, 42, 48	18, 24
	STP031R	Tall Storage Unit, w/RH Door	12, 18, 24	18, 24
	STP031L	Tall Storage Unit, w/LH Door	12, 18, 24	18, 24

TALL

## 84" TALL STORAGE UNITS

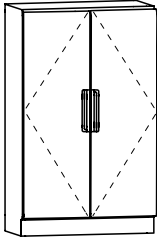
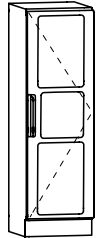
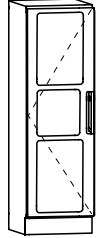
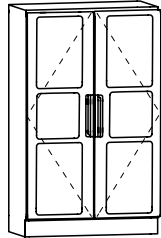
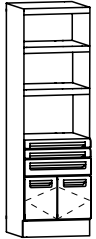
Drawing	Configuration	Description	Widths	Depths
	STP032	Tall Storage Unit, 2 Doors 36, 42, 48	24, 30	18, 24
	STP033R (Midmark Only)	Tall Storage Unit, w/RH Frame Plexi-glass Door	18, 24	18, 24
	STP033L (Midmark Only)	Tall Storage Unit, w/LH Frame Plexi-glass Door	18, 24	18, 24
	STP034 (Midmark Only)	Tall Storage Unit, 2 Frame Plexi-glass Doors	30, 36, 42, 48	18, 24
	STP080 (Midmark Only)	Tall Storage Unit, Open Upper Area, Pull Out Shelf, Writing Surface, 1—2" Drawer, 1—4" Drawer, 2 Doors	24	24

## 84" TALL STORAGE UNITS

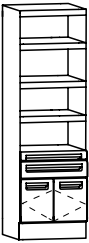
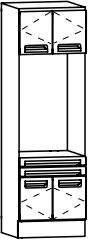
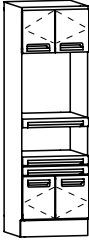
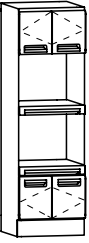
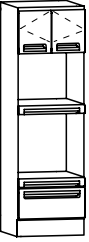
Drawing	Configuration	Description	Widths	Depths
	STP081 (Midmark Only)	Tall Storage Unit, Open Upper Area, Pull Out Shelf, 1—4" Drawer, 2 Doors	24	24
	STZ050 (Midmark Only)	Tall Steri-Center Unit, 2 Door Upper Storage, 1 Pull Out Shelf, 1 Wrapping Drawer, 2 Door Lower Storage	24	24
	STZ051 (Midmark Only)	Tall Steri-Center Unit, 2 Door Upper Storage, 2 Pull Out Shelves, 1 Wrapping Drawer, 2 Door Lower Storage	24	24
	STZ052 (Midmark Only)	Tall Steri-Center Unit, 2 Door Upper Storage, 2 Pull Out Shelves, 2 Door Lower Storage	24	24
	STZ053 (Midmark Only)	Tall Steri-Center Unit, 2 Door Upper Storage, 2 Pull Out Shelves, 1—8" Drawer	24	24

TALL

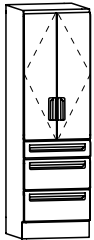

## 84" TALL STORAGE UNITS

Drawing	Configuration	Description	Widths	Depths
	STZ054 (Midmark Only)	Tall Wardrobe Unit, 2 Door Upper Storage, 1—4", 2—8" Drawers, Hanger Bar	30	24

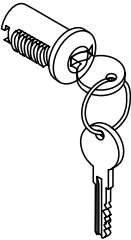
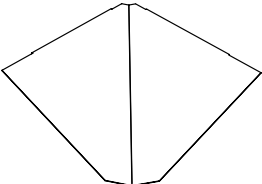
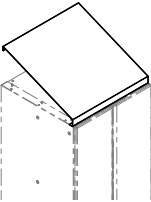
## TALL UNIT OPTIONS

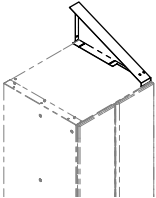
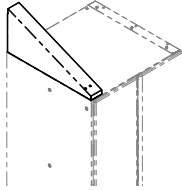
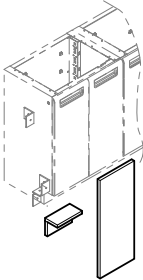

Drawing	Configuration	Description	Widths	Depths
		Locks		
	STA007	Corner Sloping Top		18, 24
	STA004	Sloping Tops		18, 24

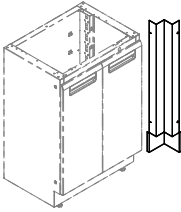
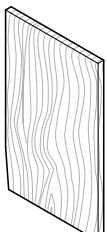
## TALL UNIT OPTIONS

Drawing	Configuration	Description	Widths	Depths
	STA005R	Sloping Top End Cap – RH		18, 24
	STA005L	Sloping Top End Cap – LH		18, 24
	STA003	6"W Filler Panel Kits  *To be cut to fit in the field.	69, 84	
	STA001	End Scribe	69, 84	
	STA002	Corner Bracket	69, 84	
	STA008 (Midmark Only)	End Panel-Wood Grain	69, 84	18, 24

TALL

## 5" HIGH HANGING DESK UNITS

Drawing	Configuration	Description	Widths	Depths
	SDH001	Hanging Desk, 1—2" Drawer	24, 30, 36, 42	18, 24
	SDH002	Hanging Desk, 2—2" Drawers	48	18, 24

## 30" HIGH FREE STANDING DESKS

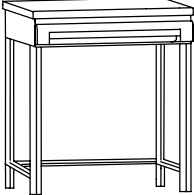
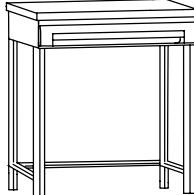
Drawing	Configuration	Description	Widths	Depths
	SDF001	Free Standing Desk w/Laminated Top, 1—2" Drawer	24, 30	18, 24
	SDF003	Free Standing Desk w/Bumper Edge Top, 1—2" Drawer	24, 30	18, 24

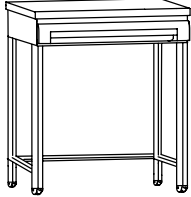
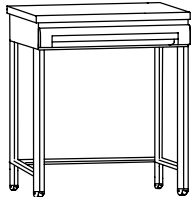

## 30" HIGH MOBILE DESKS

Drawing	Configuration	Description	Widths	Depths
	SDM001	Mobile Desk w/Laminated Top, 1—2" Drawer	24, 30	18, 24
	SDM003	Mobile Desk, w/Bumper Edge Top, 1—2" Drawer	24, 30	18, 24

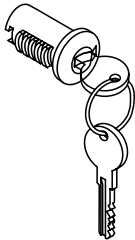
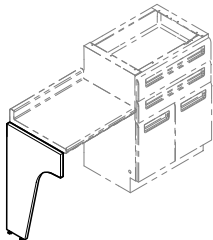
## DESK UNIT OPTIONS

Drawing	Configuration	Description	Widths	Depths
		Locks (Not available with free-standing or mobile desk units)		
	SDA005	Desk Legs		18, 24

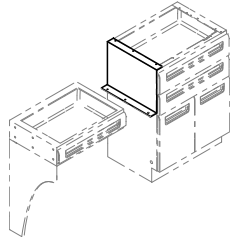
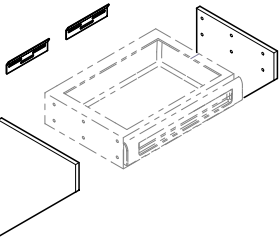
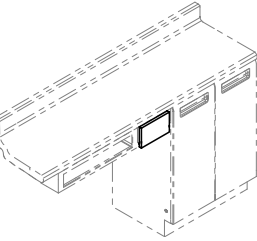
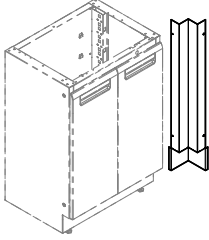
# DESK UNIT OPTIONS

Drawing	Configuration	Description	Widths	Depths
	SDA004	Drop Down Desk Bracket Includes Wall Mount Cleat		18, 24
	SDA006	Wall Mount Kit 2 - Support Panels w/Wall Mount Cleat		
	SDA003	6"W Filler Panels  *To be cut to fit in the field.		
	SDA002	Corner Brackets		
	SDA001	End Scribe		

**DESK UNIT OPTIONS**

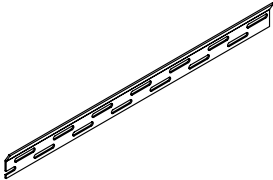
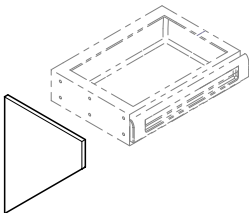
Drawing	Configuration	Description	Widths	Depths
	SDA007	Wall Mount Cleat		
	SDA008	Wall Mount Kit 1 Support Panel (No Wall Cleat)		

## 18" HIGH OVERHEAD UNITS

\*Comes standard with one adjustable shelf.

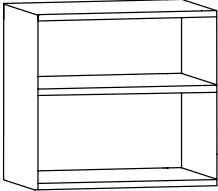
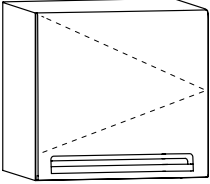
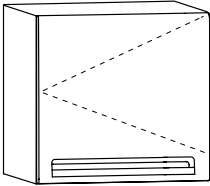
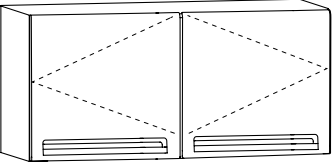
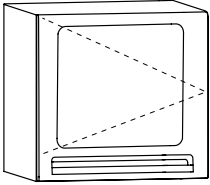
Drawing	Configuration	Description	Widths	Depths
	SOH001	Overhead, No Door	12, 15, 18, 21 24, 30, 36, 42 48	14
	SOH002R	Overhead, Door RH	12, 15, 18, 21 24	14
	SOH002L	Overhead, Door LH	12, 15, 18, 21 24	14
	SOH003	Overhead, 2 Doors	24, 30, 36, 42 48	14
	SOH004R (Midmark Only)	Overhead, Framed Plexi-glass Door RH	12, 15, 18, 21 24	14

## 18" HIGH OVERHEAD UNITS

\*Comes standard with one adjustable shelf.

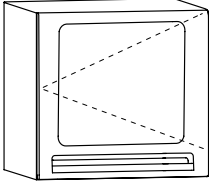
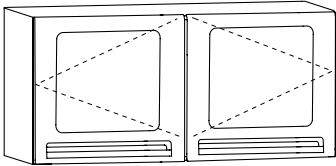
Drawing	Configuration	Description	Widths	Depths
	SOH004L (Midmark Only)	Overhead, Framed Plexi-glass Door LH	12, 15, 18, 21 24	14
	SOH005 Midmark Only)	Overhead, 2 Doors Framed Plexi-glass	24, 30, 36, 42 48	14

## 24" HIGH OVERHEAD UNITS

\*Comes standard with two adjustable shelves.

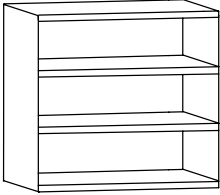
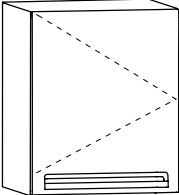
Drawing	Configuration	Description	Widths	Depths
	SOH020	Overhead, No Door	12, 15, 18, 21 24, 30, 36, 42 48	14
	SOH021R	Overhead, Door RH	12, 15, 18, 21 24	14

## 24" HIGH OVERHEAD UNITS

\*Comes standard with two adjustable shelves.

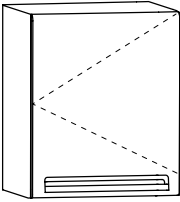
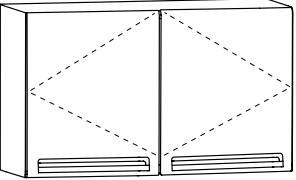
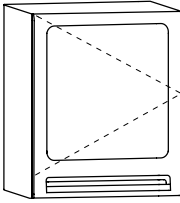
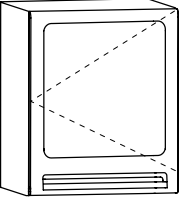
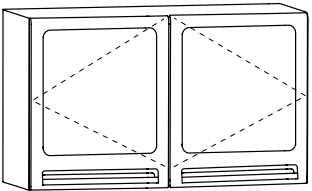
Drawing	Configuration	Description	Widths	Depths
	SOH021L	Overhead, Door LH	12, 15, 18, 21 24	14
	SOH022	Overhead, 2 Doors	24, 30, 36, 42 48	14
	SOH023R (Midmark Only)	Overhead, Framed Plexi-glass Door RH	12, 15, 18, 21 24	14
	SOH023L (Midmark Only)	Overhead, Framed Plexi-glass Door LH	12, 15, 18, 21 24	14
	SOH024 (Midmark Only)	Overhead, 2 Doors Framed Plexi-glass	24, 30, 36, 42 48	14

## 30" HIGH OVERHEAD UNITS

\*Comes standard with two adjustable shelves.

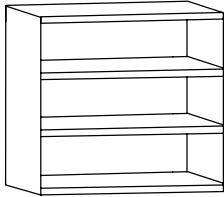
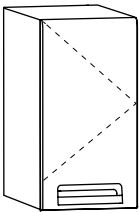
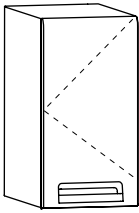
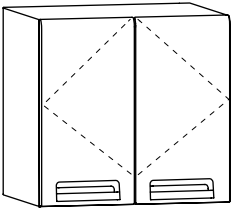
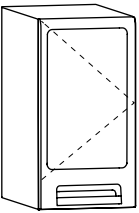
Drawing	Configuration	Description	Widths	Depths
	SOH040	Overhead, No Door	12, 15, 18, 21 24, 30, 36, 42 48	14
	SOH041R	Overhead, Door RH	12, 15, 18, 21 24	14
	SOH041L	Overhead, Door LH	12, 15, 18, 21	14 24
	SOH042	Overhead, 2 Doors	24, 30, 36, 42	14 48
	SOH043R (Midmark Only)	Overhead, Framed Plexi-glass Door RH	12, 15, 18, 21 24	14

## 30" HIGH OVERHEAD UNITS

\*Comes standard with two adjustable shelves.

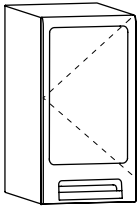
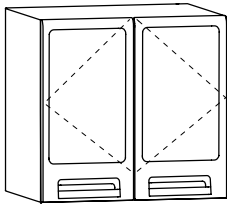
Drawing	Configuration	Description	Widths	Depths
	SOH043L (Midmark Only)	Overhead, Framed Plexi-glass Door LH	12, 15, 18, 21 24	14
	SOH044 (Midmark Only)	Overhead, 2 Doors Framed Plexi-glass	24, 30, 36, 42 48	14

## 36" HIGH OVERHEAD UNITS

\*Comes standard with three adjustable shelves.

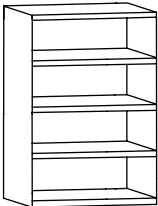
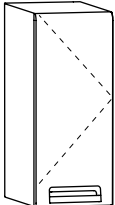
Drawing	Configuration	Description	Widths	Depths
	SOH060	Overhead, No Door	12, 15, 18, 21 24, 30, 36, 42 48	14
	SOH061R	Overhead, Door RH	12, 15, 18, 21 24	14

## 36" HIGH OVERHEAD UNITS

\*Comes standard with three adjustable shelves.

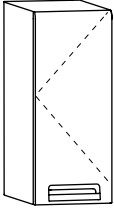
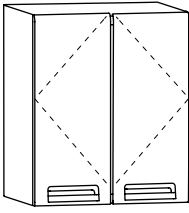
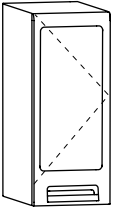
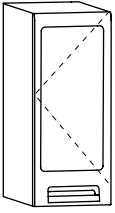
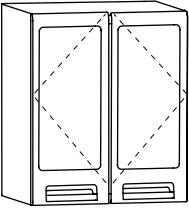
Drawing	Configuration	Description	Widths	Depths
	SOH061L	Overhead, No Door LH	12, 15, 18, 21 24	14
	SOH062	Overhead, 2 Doors	24, 30, 36, 42 48	14
	SOH063R (Midmark Only)	Overhead, Framed Plexi-glass Door RH	12, 15, 18, 21 24	14
	SOH063L (Midmark Only)	Overhead, Framed Plexi-glass Door LH	12, 15, 18, 21 24	14
	SOH064 (Midmark Only)	Overhead, 2 Doors Framed Plexi-glass	24, 30, 36, 42 48	14

## 24" HIGH OVERHEAD NARCOTICS UNITS

\*Comes standard with two adjustable shelves.

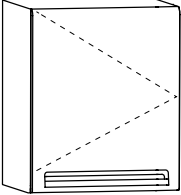
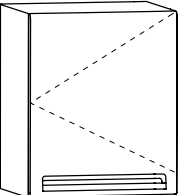
Drawing	Configuration	Description	Widths	Depths
	SON001R	Overhead, Narcotics, Door RH	18, 24	14
	SON001L	Overhead, Narcotics, Door LH	18, 24	14

## 30" HIGH OVERHEAD NARCOTICS UNITS

\*Comes standard with two adjustable shelves.

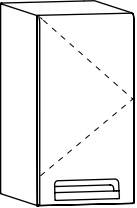
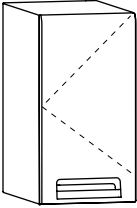
Drawing	Configuration	Description	Widths	Depths
	SON010R	Overhead, Narcotics, Door RH	18, 24	14
	SON010L	Overhead, Narcotics, Door LH	18, 24	14

## 18" HIGH CORNER OVERHEAD UNITS

\*Comes standard with one adjustable shelf.

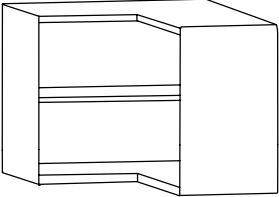
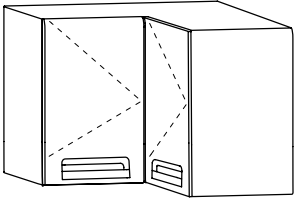
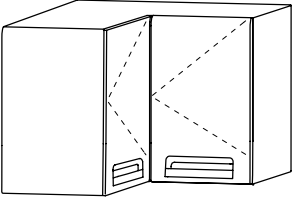
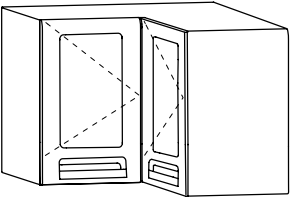
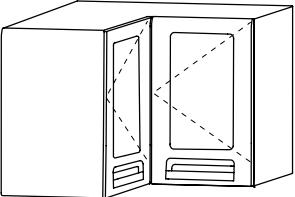
Drawing	Configuration	Description	Widths	Depths
	SOC001	Corner Overhead, No Door	27	14
	SOC003R	Corner Overhead, 90° 1 Bi-fold Door RH	27	14
	SOC003L	Corner Overhead, 90° 1 Bi-fold Door LH	27	14
	SOC005R (Midmark Only)	Corner Overhead, 90° 1 Bi-fold Framed Plexi-glass Door RH	27	14
	SOC005L (Midmark Only)	Corner Overhead, 90° 1 Bi-fold Framed Plexi-glass Door LH	27	14

## 24" HIGH CORNER OVERHEAD UNITS

\*Comes standard with two adjustable shelves.

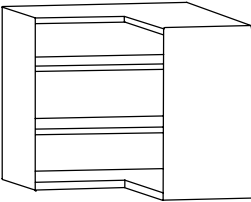
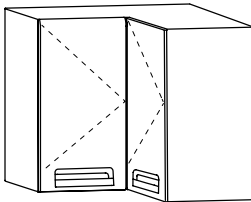
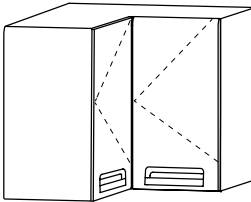
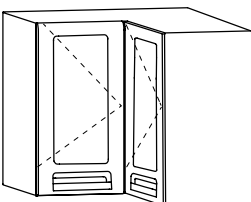
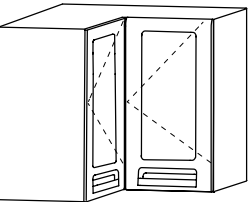
Drawing	Configuration	Description	Widths	Depths
	SOC015	Corner Overhead, No Door	27	14
	SOC017R	Corner Overhead, 90° 1 Bi-fold Door RH	27	14
	SOC017L	Corner Overhead, 90° 1 Bi-fold Door LH	27	14
	SOC019R (Midmark Only)	Corner Overhead, 90° 1 Bi-fold Framed Plexi-glass Door RH	27	14
	SOC019L (Midmark Only)	Corner Overhead, 90° 1 Bi-fold Framed Plexi-glass Door LH	27	14

## 30" HIGH CORNER OVERHEAD UNITS

\*Comes standard with two adjustable shelves.

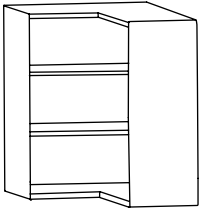
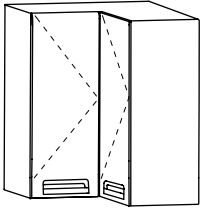
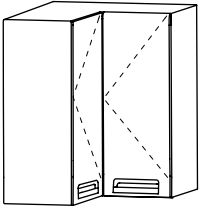
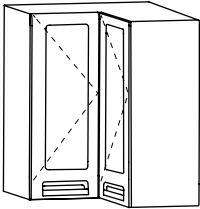
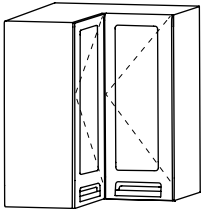

Drawing	Configuration	Description	Widths	Depths
	SOC030	Corner Overhead, No Door	27	14
	SOC032R	Corner Overhead, 90° 1 Bi-fold Door RH	27	14
	SOC032L	Corner Overhead, 90° 1 Bi-fold Door LH	27	14
	SOC034R (Midmark Only)	Corner Overhead, 90° 1 Bi-fold Framed Plexi-glass Door RH	27	14
	SOC034L (Midmark Only)	Corner Overhead, 90° 1 Bi-fold Framed Plexi-glass Door LH	27	14

## 36" HIGH CORNER OVERHEAD UNITS

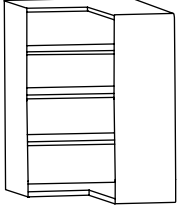
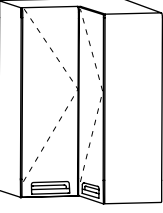
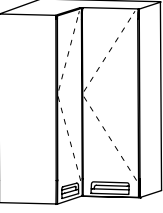
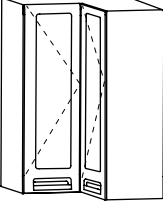
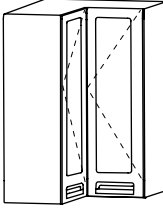
\*Comes standard with three adjustable shelves.

Drawing	Configuration	Description	Widths	Depths
	SOC045	Corner Overhead, No Door	27	14
	SOC047R	Corner Overhead, 90° 1 Bi-fold Door RH	27	14
	SOC047L	Corner Overhead, 90° 1 Bi-fold Door LH	27	14
	SOC049R (Midmark Only)	Corner Overhead, 90° 1 Bi-fold Framed Plexi-glass Door RH	27	14
	SOC049L (Midmark Only)	Corner Overhead, 90° 1 Bi-fold Framed Plexi-glass Door LH	27	14

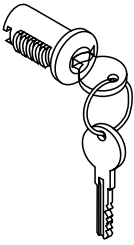
**OVERHEAD OPTIONS**

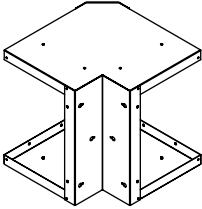
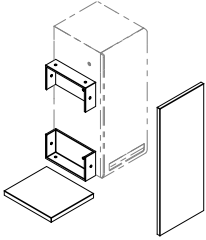
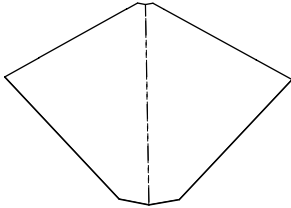
Drawing	Configuration	Description	Widths	Depths
		Locks		
	SOA001	Metal End Scribes	18, 24, 30, 36	
	SOA002	Overhead Corner Bracket	18, 24, 30, 36	14
	SOA003	6"W Filler Panel Kits	18, 24, 30, 36	14
		*To be cut to fit the field.		
	SOA006	Corner Sloping Top		14

**OVERHEAD OPTIONS**

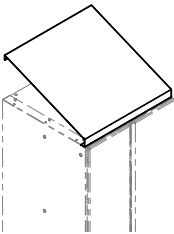
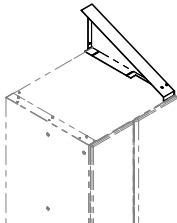
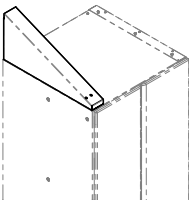
Drawing	Configuration	Description	Widths	Depths
	SOA004	Sloping Top		14
	SOA005R	Sloping Top End Cap – RH		14
	SOA005L	Sloping Top End Cap – LH		14

## OVERHEAD OPTIONS

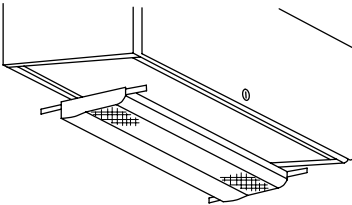
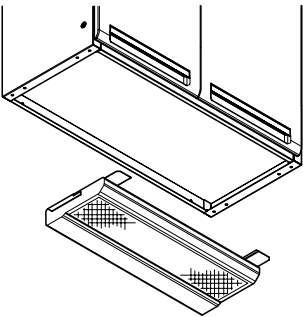
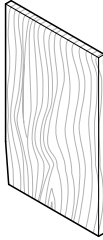
Drawing	Configuration	Description	Widths	Depths	
	SOA010	Task Light – Daisy Chain	18, 36	14	
	SOA011	Daisy Chain Jumper Cords for Task Light	42, 54, 78	NA	
Recessed Lighting	SOA012	Task Light – 9 Ft. Fused Cord	18, 36	14	
	SOA008	Task Light – 9 Ft. Cord	18, 36	14	
	SOA009	Task Light – Hard Wired	18, 36	14	
	SOA013	Task Light – Flexible Mounting Bracket			
	Non-Recessed Lighting	SOA014 (Midmark Only)	End Panel-Wood Grain	18, 24, 30, 36	14
					

**33" HIGH MOBILE CART W/ BUMPER EDGE TOP**

Drawing	Configuration	Description	Widths	Depths
	SML001	Mobile Cart, 1—4" Drawer, 2 Doors	24	18, 24
	SML002	Mobile Cart, 2—4" Drawers, 2 Doors	24	18, 24
	SML003	Mobile Cart, 1—4" Drawer, 2—8" Drawers	24	18, 24
	SML004	Mobile Cart, 3—4" Drawers, 1—8" Drawer	24	18, 24
	SML005	Mobile Cart, 2—2", 2—4", 1—8" Drawer	24	18, 24

### 33" HIGH MOBILE CART W/ BUMPER EDGE TOP

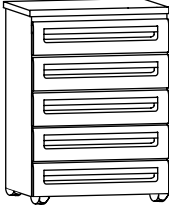
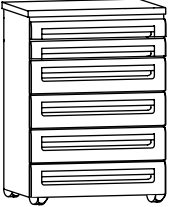
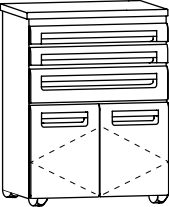
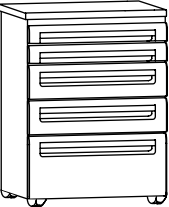
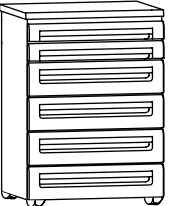
Drawing	Configuration	Description	Widths	Depths
	SML006	Mobile Cart, 5—4" Drawers	24	18, 24
	SML007	Mobile Cart, 2—2", 4—4" Drawers	24	18, 24
	SML010	Mobile Cart w/Writing Surface, 1—2", 1—4" Drawers, 2 Doors	24	18, 24
	SML011	Mobile Cart w/Writing Surface, 1—2", 2—4", 1—8" Drawers	24	18, 24
	SML011	Mobile Cart w/Writing Surface, 1—2", 4—4" Drawers	24	18, 24

### 33" HIGH MOBILE CART W/LAMINATE TOP OR KYDEX TOP

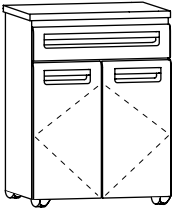
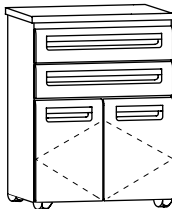
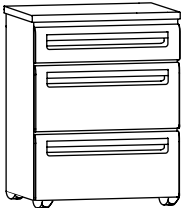
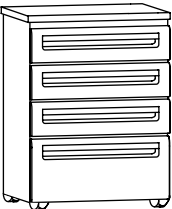
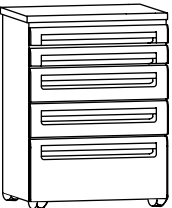
Drawing	Configuration	Description	Widths	Depths
	SML013	Mobile Cart, 1—4" Drawer, 2 Doors	24	18, 24
	SML014	Mobile Cart, 2—4" Drawers, 2 Doors	24	18, 24
	SML015	Mobile Cart, 1—4" Drawer, 2—8" Drawers	24	18, 24
	SML016	Mobile Cart, 3—4" Drawers, 1—8" Drawers	24	18, 24
	SML017	Mobile Cart, 2—2", 2—4", 1—8" Drawers	24	18, 24

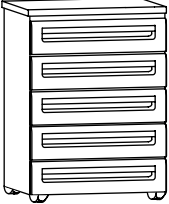
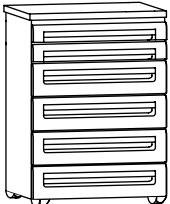
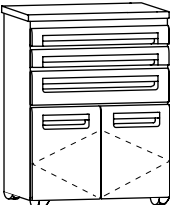
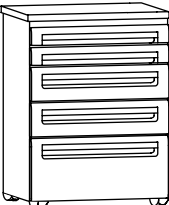
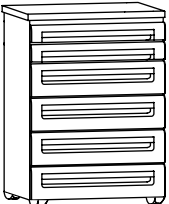

33" HIGH MOBILE CART W/LAMINATE TOP OR KYDEX TOP

Drawing	Configuration	Description	Widths	Depths
	SML018	Mobile Cart, 5—4" Drawers	24	18, 24
	SML019	Mobile Cart, 2—2", 4—4" Drawers	24	18, 24
	SML022	Mobile Cart w/Writing Surface, 1—2", 1—4" Drawers, 2 Doors	24	18, 24
	SML023	Mobile Cart w/Writing Surface, 1—2", 2—4", 1—8" Drawers	24	18, 24
	SML024	Mobile Cart w/Writing Surface, 1—2", 4—4" Drawers	24	18, 24

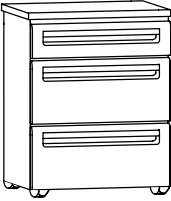
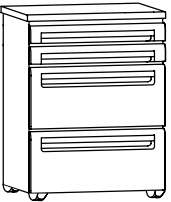
### 33" HIGH MOBILE FILE

Drawing	Configuration	Description	Widths	Depths
	SMF001	Mobile File, 1—4", 2 File Drawers	18, 21, 24	18, 24
	SMF002	Mobile File w/Writing Surface, 1—2", 2 File Drawers	24	18, 24

### 27" HIGH MOBILE FILE

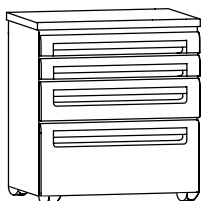
Drawing	Configuration	Description	Widths	Depths
	SMF005	Mobile File, 2 File Drawers	18, 21, 24	18, 24
	SMF006	Mobile File, 2—4", 1 File Drawers	18, 21, 24	18, 24
	SMF007	Mobile File w/Writing Surface, 1—2", 1—4", 1 File Drawers	24	18, 24

## MOBILE OPTIONS

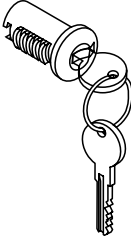
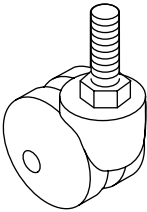
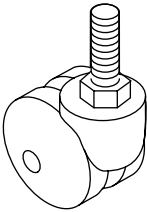
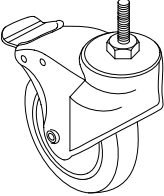
Drawing	Configuration	Description	Widths	Depths
		Locks		
	31200-00013	3" Hard Surface, Locking (Factory Installed)		Set of 4
	31200-00012	2" Hard Surface, Locking (Standard)		
	016-1199-00	4" Hard Surface, Locking (Optional)		Set of 4

## SPECIALITY UNITS

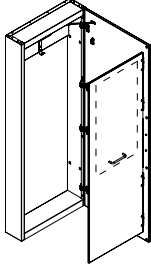
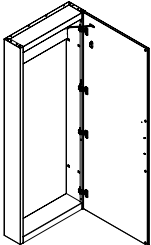
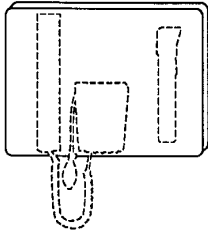
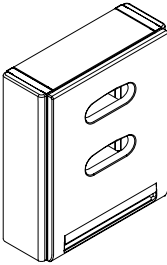
Drawing	Configuration	Description	Widths	Depths
	264-001-XXX	Dressing Nook, Ritter, RH	24	6
	264-002-XXX	Dressing Nook, Ritter, LH	24	6
	664-001-XXX	Dressing Nook, Midmark, RH	24	6
	664-002-XXX	Dressing Nook, Midmark, LH	24	6
	SSP002R	Scope Cabinet, Door RH	24	6
	SSP002L	Scope Cabinet, Door LH	24	6
*Scope hanger not included.				
	663-001-XXX	Instrument Panel, Midmark	30	19 (H)
	663-002-XXX	Instrument Panel, Midmark	34	19 (H)
	263-001-XXX	Instrument Panel, Ritter	30	19 (H)
	263-002-XXX	Instrument Panel, Ritter	34	19 (H)
	662-001-XXX	Glove/Towel/Cup Dispenser, Door RH	18 3/4	21 1/2 (H)
	662-002-XXX	Glove/Towel/Cup Dispenser, Door LH		

**COUNTERTOPS**

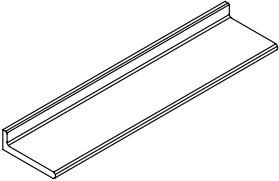
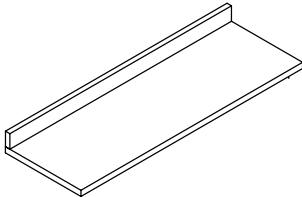
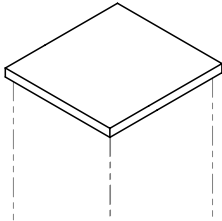
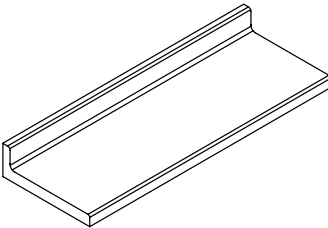
Drawing	Configuration	Description	Widths	Depths
		Laminate Post Formed, 180° Rolled		19, 25
		Laminate Self Edge w/Backsplash		19, 25, 31
		Laminate Island, Self Edge		26, 44, 50
		Corian .375" radius, 1" Thick x 3" high Backsplash  *Corian countertops that require seams must be installed by a Certified Fabricator		19, 25

**COUNTERTOPS**

## COUNTERTOPS, ACCESSORIES

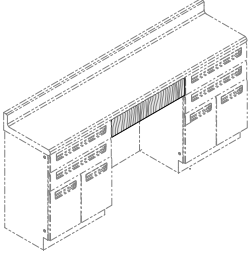
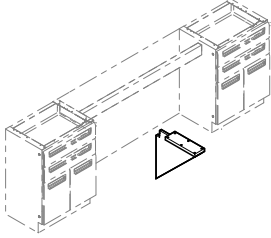
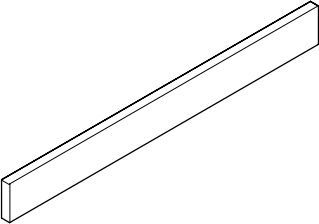
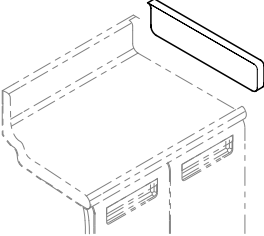
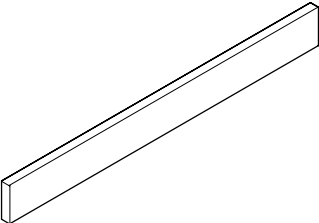
Drawing	Configuration	Description	Widths	Depths
		<p>Sink Aprons</p> <p>*Can be cut to size.</p>		36, 48
	<p>9056-003 9056-004</p>	<p>19" Deep Braces 25" Deep Braces</p>		19, 25
		<p>Corian Sidesplash 1/2" thick x 3" high</p> <p>*Corian countertops that require seams must be installed by a Certified Fabricator</p>		
	<p>062-49xx-04-XXX 062-49xx-05-XXX</p>	<p>19" Sidesplash, Postform 25" Sidesplash, Postform</p>		19, 25
	<p>069-2800-00-000 069-2800-00-001</p>	<p>19" Sidesplash, Self edge 25" Sidesplash, Self edge</p>		19, 25

**COUNTERTOPS, ACCESSORIES**

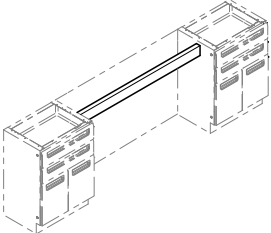
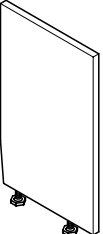
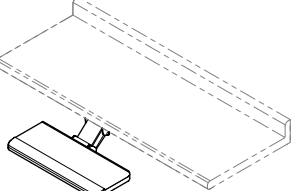
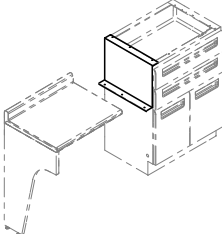
Drawing	Configuration	Description	Widths	Depths
	062-5800-00-216	Running Support	2	48"
	SCA001	Support Legs	30, 34, 36	18, 24, 30
	SSP010	Keyboard Tray/Arm	21	
	SCA002	Drop-Down Countertop Support		18, 24

**COUNTERTOPS**

## GENERAL ACCESSORIES

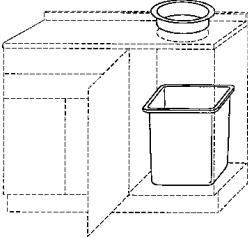
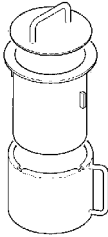
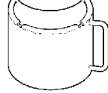
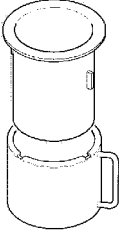
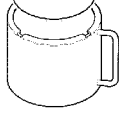
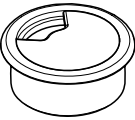
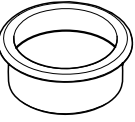
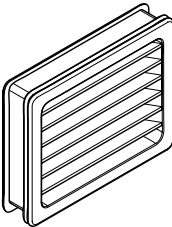
Drawing	Configuration	Description	Widths	Depths
	9061-001	Waste Grommet/Trash Can	6	
	DM-AWC001	4" Bio-hazardous Grommet with Lid	4	
	DM-AWC003	6" Bio-hazardous Grommet with Lid	6	
	DM-AWC002	4" Bio-hazardous Grommet without Lid	4	
	DM-AWC004	6" Bio-hazardous Grommet without Lid	6	
	053-0452-03	2" Electrical Grommet, Putty/Black	2	
	053-0408-00	6" Trash Grommet/Black	6	
	016-0944-00	CPU Vent	4.625	

## MIDMARK EXAM ROOM CASEWORK

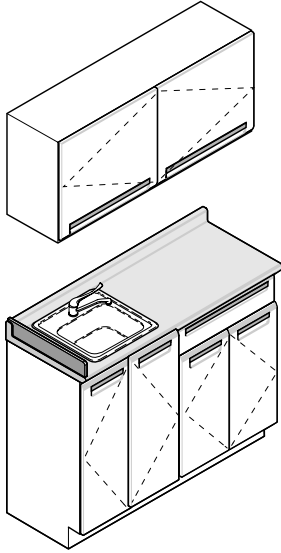

### **MODEL:**

LC-MLSNP-XXX  
LC-MRSNP-XXX  
LC-MLDNP-XXX  
LC-MRDNP-XXX  
LC-MLSSP-XXX  
LC-MRSSP-XXX  
LC-MLDSP-XXX  
LC-MRDSP-XXX

### **DESCRIPTION:**

Left-handed single door, no sink/faucet  
Right-handed single door, no sink/faucet  
Left-handed double doors, no sink/faucet  
Right-handed double doors, no sink/faucet  
Left-handed single door, sink/faucet  
Right-handed single door, sink/faucet  
Left-handed double doors, sink/faucet  
Right-handed double doors, sink/faucet

## BASIC

### *Exam Room Casework*

- Overhead Cabinet 48"W x 24"H x 14"D
- Base Cabinet 48"W x 36"H to top of counter x 18"D (39"H to top of backsplash)
- Minimally Featured, See Product Specifications. (Left-handed shown)
- Standard colors are Pebble Grey sides, drawers & doors.
- Please specify color of countertop and inserts for doors and drawers. See Midmark color chart for standard choices. Available in Woodgrain with upcharge.

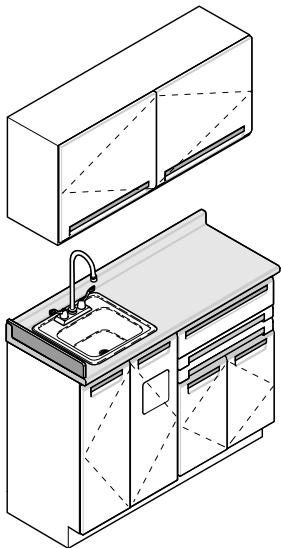

### **MODEL:**

BV-MLSNP-XXX  
BV-MRSNP-XXX  
BV-MLDNP-XXX  
BV-MRDNP-XXX  
BV-MLSSP-XXX  
BV-MRSSP-XXX  
BV-MLDSP-XXX  
BV-MRDSP-XXX

### **DESCRIPTION:**

Left-handed single door, no sink/faucet  
Right-handed single door, no sink/faucet  
Left-handed double doors, no sink/faucet  
Right-handed double doors, no sink/faucet  
Left-handed single door, sink/faucet  
Right-handed single door, sink/faucet  
Left-handed double doors, sink/faucet  
Right-handed double doors, sink/faucet

## BEST VALUE

### *Exam Room Casework*

- Overhead Cabinet 48"W x 24"H x 14"D
- Base Cabinet 48"W x 36"H to top of counter x 18"D (39"H to top of backsplash)
- Full Featured, See Product Specifications. (Left-handed shown)
- Standard colors are Pebble Grey sides, drawers & doors.
- Please specify color of countertop and inserts for doors and drawers. See Midmark color chart for standard choices. Available in Woodgrain with upcharge.

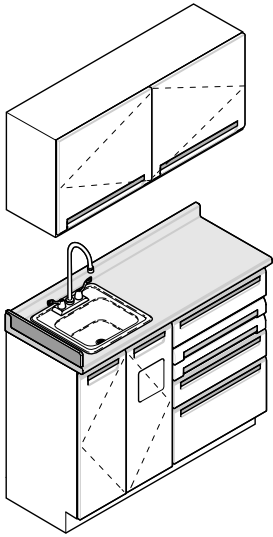

## MANAGED CARE

### Exam Room Casework

- Overhead Cabinet 48"W x 24"H x 14"D
- Base Cabinet 48"W x 36"H to top of counter x 18"D (39"H to top of backsplash)
- Full Featured, See Product Specifications. (Left-handed shown)
- Standard colors are Pebble Grey sides, drawers & doors.
- Please specify color of countertop and inserts for doors and drawers. See Midmark color chart for standard choices. Available in Woodgrain with upcharge.

#### **MODEL:**

MC-MLSNP-XXX  
 MC-MRSNP-XXX  
 MC-MLDNP-XXX  
 MC-MRDNP-XXX  
 MC-MLSSP-XXX  
 MC-MRSSP-XXX  
 MC-MLDSP-XXX  
 MC-MRDSP-XXX

#### **DESCRIPTION:**

Left-handed single door, no sink  
 Right-handed single door, no sink  
 Left-handed double doors, no sink  
 Right-handed double doors, no sink  
 Left-handed single door, sink  
 Right-handed single door, sink  
 Left-handed double doors, sink  
 Right-handed double doors, sink

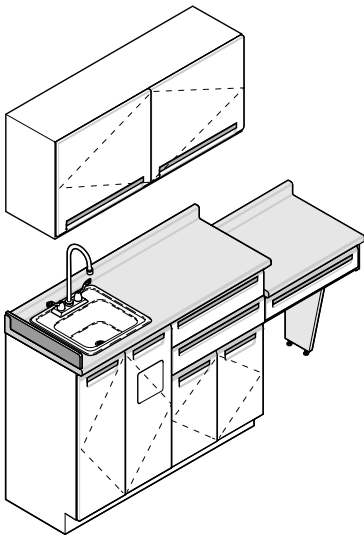

## TRADITIONAL

### Exam Room Casework

- Overhead Cabinet 48"W x 24"H x 14"D
- Base Cabinet 73"W x 36"H to top of counter x 18"D (39"H to top of backsplash)
- Desk mounted at 30" to top of counter (33"H to top of backsplash)
- Full Featured, See Product Specifications. (Left-handed shown)
- Standard colors are Pebble Grey sides, drawers & doors.
- Please specify color of countertop and inserts for doors and drawers. See Midmark color chart for standard choices. Available in Woodgrain with upcharge.

#### **MODEL:**

TR-MLSNP-XXX  
 TR-MRSNP-XXX  
 TR-MLDNP-XXX  
 TR-MRDNP-XXX  
 TR-MLSSP-XXX  
 TR-MRSSP-XXX  
 TR-MLDSP-XXX  
 TR-MRDSP-XXX

#### **DESCRIPTION:**

Left-handed single door, no sink  
 Right-handed single door, no sink  
 Left-handed double doors, no sink  
 Right-handed double doors, no sink  
 Left-handed single door, sink  
 Right-handed single door, sink  
 Left-handed double doors, sink  
 Right-handed double doors, sink

## RITTER EXAM ROOM CASEWORK

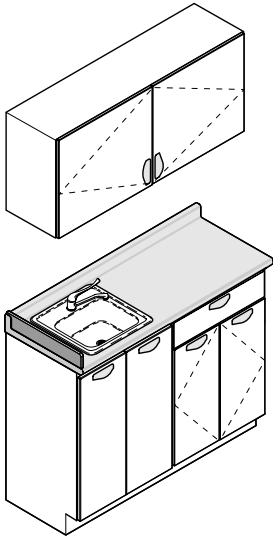

### **MODEL:**

LC-RLSNP-XXX  
LC-RRSNP-XXX  
LC-RLDNP-XXX  
LC-RRDNP-XXX  
LC-RLSSP-XXX  
LC-RRSSP-XXX  
LC-RLDSP-XXX  
LC-RRDSP-XXX

### **DESCRIPTION:**

Left-handed single door, no sink/faucet  
Right-handed single door, no sink/faucet  
Left-handed double doors, no sink/faucet  
Right-handed double doors, no sink/faucet  
Left-handed single door, sink/faucet  
Right-handed single door, sink/faucet  
Left-handed double doors, sink/faucet  
Right-handed double doors, sink/faucet

## BASIC

### *Exam Room Casework*

- Overhead Cabinet 48"W x 24"H x 14"D
- Base Cabinet 48"W x 36"H to top of counter x 18"D (39"H to top of backsplash)
- Minimally Featured, See Product Specifications. (Left-handed shown)
- Standard color is Pebble Grey sides.
- Please specify color of countertop and panels for doors and drawers. See Midmark color chart for standard choices.

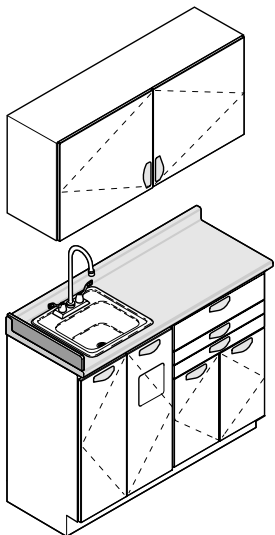

### **MODEL:**

BV-RLSNP-XXX  
BV-RRSNP-XXX  
BV-RLDNP-XXX  
BV-RRDNP-XXX  
BV-RLSSP-XXX  
BV-RRSSP-XXX  
BV-RLDSP-XXX  
BV-RRDSP-XXX

### **DESCRIPTION:**

Left-handed single door, no sink/faucet  
Right-handed single door, no sink/faucet  
Left-handed double doors, no sink/faucet  
Right-handed double doors, no sink/faucet  
Left-handed single door, sink/faucet  
Right-handed single door, sink/faucet  
Left-handed double doors, sink/faucet  
Right-handed double doors, sink/faucet

## BEST VALUE

### *Exam Room Casework*

- Overhead Cabinet 48"W x 24"H x 14"D
- Base Cabinet 48"W x 36"H to top of counter x 18"D (39"H to top of backsplash)
- Full Featured, See Product Specifications. (Left-handed shown)
- Standard color is Pebble Grey sides.
- Please specify color of countertop and panels for doors and drawers. See Midmark color chart for standard choices.

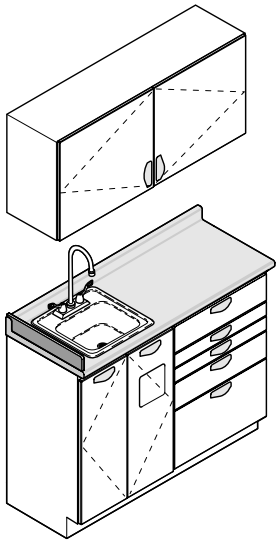

## MANAGED CARE

### Exam Room Casework

- Overhead Cabinet 48"W x 24"H x 14"D
- Base Cabinet 48"W x 36"H to top of counter x 18"D (39"H to top of backsplash)
- Full Featured, See Product Specifications. (Left-handed shown)
- Standard color is Pebble Grey sides.
- Please specify color of countertop and panels for doors and drawers. See Midmark color chart for standard choices.

#### **MODEL:**

MC-RLSNP-XXX  
 MC-RRSNP-XXX  
 MC-RLDNP-XXX  
 MC-RRDNP-XXX  
 MC-RLSSP-XXX  
 MC-RRSSP-XXX  
 MC-RLDSP-XXX  
 MC-RRDSP-XXX

#### **DESCRIPTION:**

Left-handed single door, no sink  
 Right-handed single door, no sink  
 Left-handed double doors, no sink  
 Right-handed double doors, no sink  
 Left-handed single door, sink  
 Right-handed single door, sink  
 Left-handed double doors, sink  
 Right-handed double doors, sink

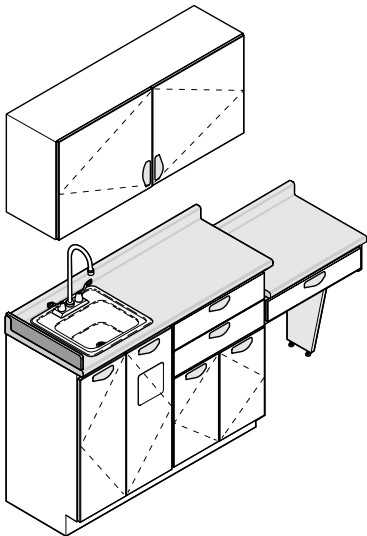

## TRADITIONAL

### Exam Room Casework

- Overhead Cabinet 48"W x 24"H x 14"D
- Base Cabinet 73"W x 36"H to top of counter x 18"D (39"H to top of backsplash)
- Desk mounted at 30" to top of counter (33"H to top of backsplash)
- Full Featured, See Product Specifications. (Left-handed shown)
- Standard color is Pebble Grey sides.
- Please specify color of countertop and panels for doors and drawers. See Midmark color chart for standard choices.

#### **MODEL:**

TR-RLSNP-XXX  
 TR-RRSNP-XXX  
 TR-RLDNP-XXX  
 TR-RRDNP-XXX  
 TR-RLSSP-XXX  
 TR-RRSSP-XXX  
 TR-RLDSP-XXX  
 TR-RRDSP-XXX

#### **DESCRIPTION:**

Left-handed single door, no sink  
 Right-handed single door, no sink  
 Left-handed double doors, no sink  
 Right-handed double doors, no sink  
 Left-handed single door, sink  
 Right-handed single door, sink  
 Left-handed double doors, sink  
 Right-handed double doors, sink

## NOTES

## NOTES

## NOTES

## It's Easy to Work with Midmark!

Look for these other helpful tools when selecting and ordering casework from Midmark.

- Midmark & Ritter Modular Casework Color Selection Guide
- AutoCAD Blocks/CAP Program
- Midmark & Ritter Casework Literature
- For more information, see us at [midmark.com](http://midmark.com)



**CARB 93120.2 Phase 1 Compliant**

**Midmark is an ISO 13485 and ISO 9001 Certified Company.**  
For more information or a demonstration, contact your Midmark dealer or call: 1-800-MIDMARK Fax: 1-800-365-2499 or visit our website at [midmark.com](http://midmark.com)

© 1998 Midmark Corporation  
60 Vista Drive P.O. Box 286 Versailles, Ohio 45380-0286  
Products subject to improvement changes without notice  
Litho in U.S.A. 007-0089-00 E1 (12/09)



Because we care.