



Vantage®

ECONOMY-GRADE SURGICAL INSTRUMENTS

Miltex
Redefining Excellence



TABLE OF CONTENTS

Diagnostic	1
Scissors	2-4
Forceps	5-12
Needle Holders	13-14
Suture	15
Retractors	16
Intestinal	17
Eye	18-19
Ear and Nasal	20-21
Orthopedic	22
Gynecological	23
Dermal	24
Instrument Care Steps	
Instrument Care Products	



The Vantage® Advantage

Surgical Instruments

All manufactured with high grade Japanese Stainless Steel unless otherwise indicated. Illustrations signify general design only.

Vantage® is a registered trademark of Miltex, Inc.

Instrument Care Products



3-700

3-705

3-710

3-725

3-720

3-726

3-755

3-750



3-760



3-740



3-800
(set)

3-1000

3-1001

3-810

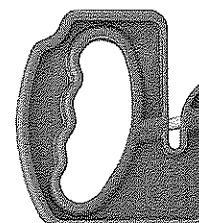

5-5000

The Miltex care and cleaning product portfolio is designed to provide optimum cleaning performance and will help to prolong the service life of valuable surgical and dental instrumentation. Many products are available in multiple sizes, including single-dose packets for ease of use, space-saving 8 oz. bottles, and 1-gallon bulk containers with pump dispensers.

REF	Description
3-700	MILTEX Spray Lubricant, 8 fl. oz. spray bottle (0.24 liters) (case of 12)
3-705	MILTEX Lubricant, 1-gallon bottle (3.78 liters).
3-710	MILTEX Surgical Instrument Cleaner/Lubricant, 1-gallon bottle (3.78 liters).
3-720	MILTEX Surgical Instrument Cleaner, 8 fl. oz. bottle (0.24 liters). Contents of 8 oz. bottle makes 32 gallons of solution.
3-725	MILTEX Surgical Instrument Cleaner, 1-gallon bottle (3.78 liters). Contents of 1-gallon bottle makes 512 gallons of solution.
3-726	MILTEX Surgical Instrument Cleaner, Box 80 – 1/4 oz. (7.4 ml) packets. Contents of 1 box makes 80 gallons of solution.
3-740	MILTEX Surgical Instrument Stain Remover, 3 oz. (85g) jar (case of 12)
3-750	MILTEX EZ-Zyme®, All Purpose Enzyme Cleaner, Box 32 – 3/4 oz. (22 ml) packets. Contents of 1 box makes 32 gallons of solution.
3-755	MILTEX EZ-Zyme®, All Purpose Enzyme Cleaner, 1-gallon bottle (3.78 liters). Contents of 1-gallon bottle makes 170 gallons of solution.
3-760	MILTEX Instrument Prep Enzyme Foam, 24 oz. (0.71 liters) spray bottles (case of 12)
3-800	MILTEX Instrument Care System Kit includes one each of Spray Lube, Surgical Instrument Cleaner (8 oz.), Surgical Instrument Stain Remover, Instrument Care Video/DVD, Nylon Brush, Stainless Steel Brush.
3-810	MILTEX Instrument Care DVD, 25-minute instructional DVD designed to help practitioners and staff properly care for instruments
3-1000	MILTEX Nylon Instrument Cleaning Brushes, 7-1/4" (18.4 cm) (set of 3)
3-1001	MILTEX Stainless Steel Instrument Cleaning Brushes, 7-1/4" (18.4 cm) (set of 3)
5-5000	MILTEX Edge Scissors Sharpener, not intended for serrated or SuperCut scissors

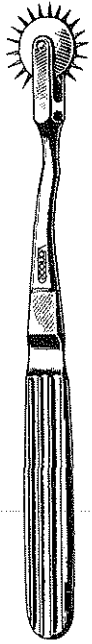

V91-226

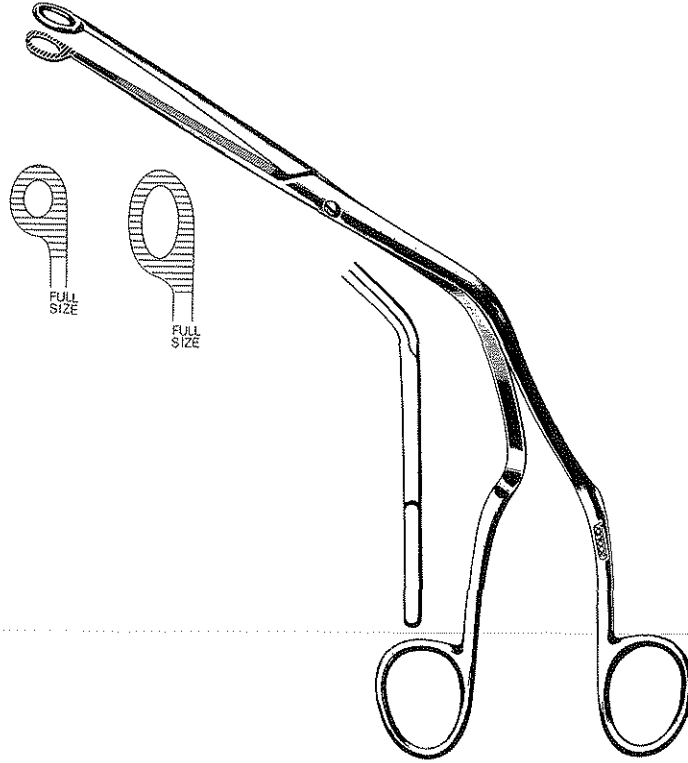

V92-70
V92-72

V91-226 WARTENBERG Neurological Pin Wheel 7"

V92-70 MAGILL Endotracheal Catheter Introducing Forceps 9", adult size (large ring jaws)

V92-72 MAGILL Endotracheal Catheter Introducing Forceps 7", child size (small ring jaws)

V93-10 Three-Prong Sterilizer Forceps 8"

65-25 Grasping Forceps 6 1/4", designed to pick up small items like needles, burs, etc.

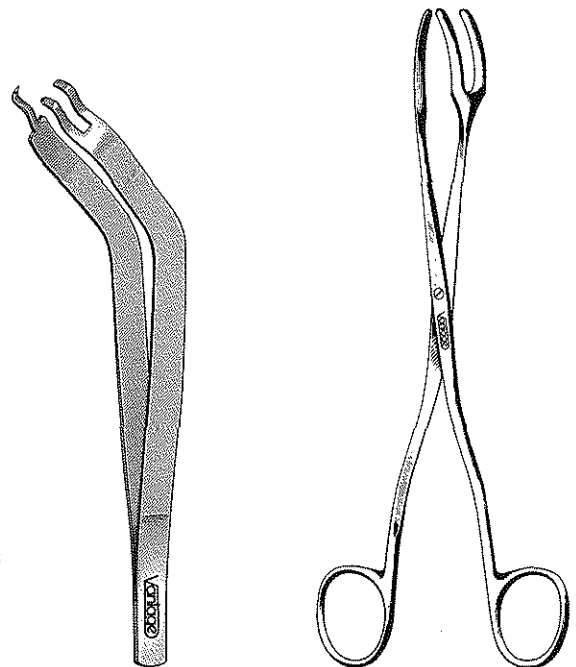

65-25

V93-10

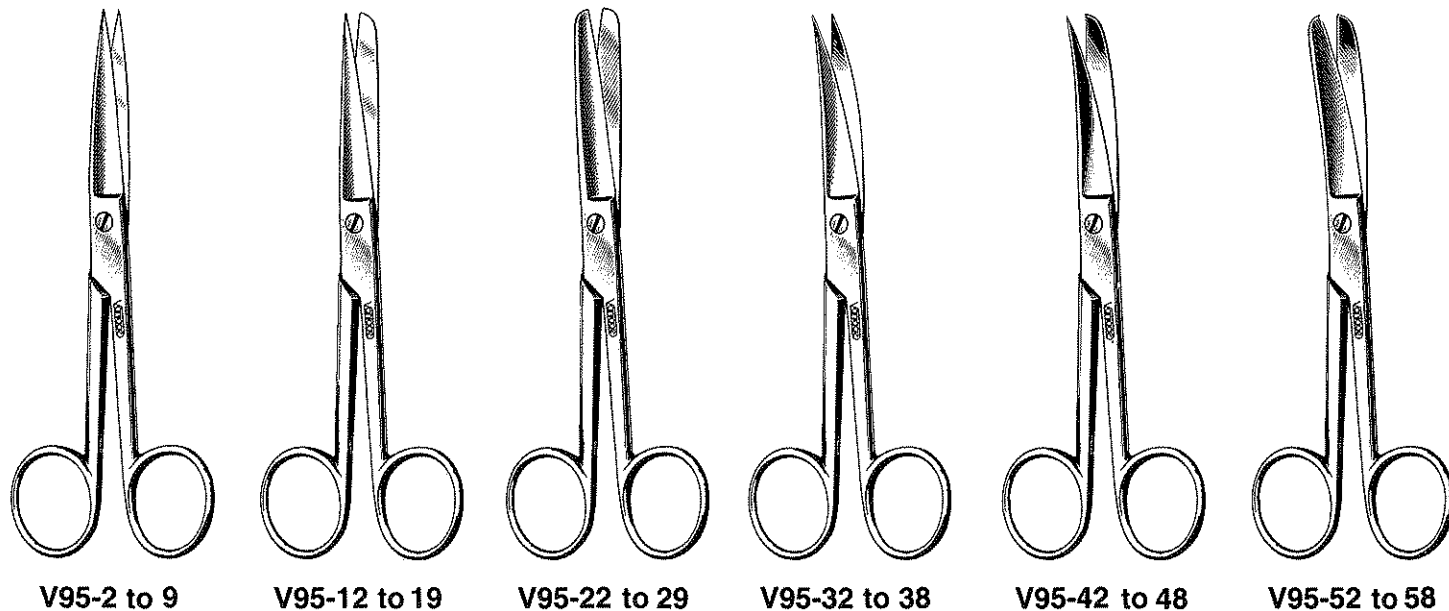

OPERATING SCISSORS (Standard Pattern)

Straight	Sharp-Sharp Points	Curved
V95-2	4½"	V95-32
V95-4	5"	—
V95-6	5½"	V95-36
V95-8	6½"	V95-38
V95-9	7½"	—
	Sharp-Blunt Points	
V95-12	4½"	V95-42
V95-16	5½"	V95-46
V95-18	6½"	V95-48
V95-19	7½"	—
	Blunt-Blunt Points	
V95-22	4½"	V95-52
V95-26	5½"	V95-56
V95-28	6½"	V95-58
V95-29	7½"	—

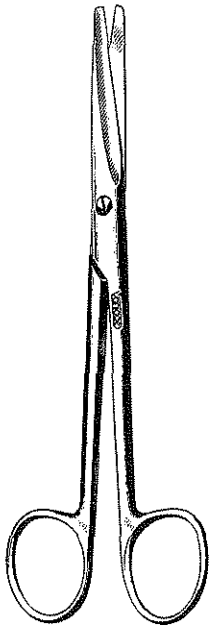

V95-120
V95-124

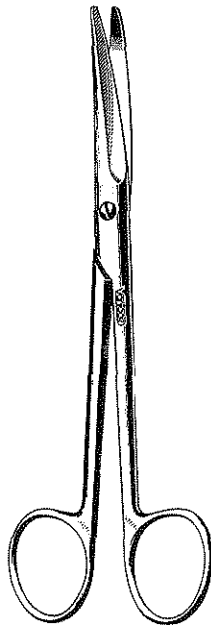

V95-122
V95-126

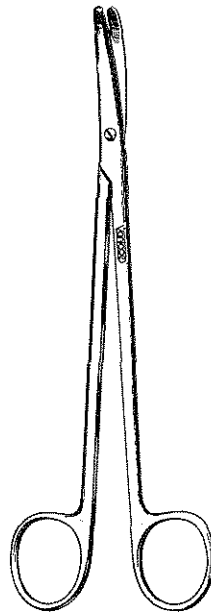

V95-180
V95-182

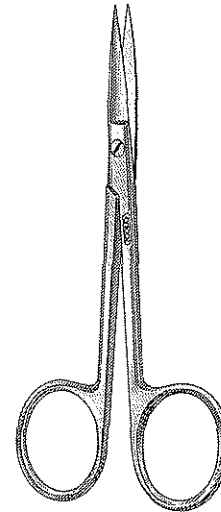

V95-304

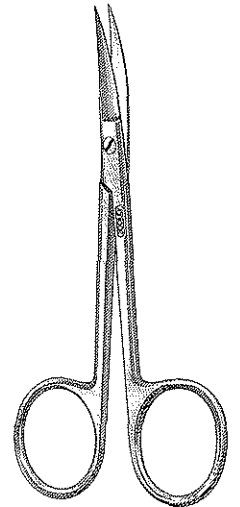

V95-306

V95-120 MAYO Dissecting Scissors 5 1/2", straight
V95-124 MAYO Dissecting Scissors 6 3/4", straight

V95-122 MAYO Dissecting Scissors 5 1/2", curved
V95-126 MAYO Dissecting Scissors 6 3/4", curved

V95-180 METZENBAUM Dissecting Scissors 5 1/2", curved
V95-182 METZENBAUM Dissecting Scissors 7", curved

V95-304 Iris Scissors 4 1/8", straight
V95-306 Iris Scissors 4 1/8", curved

V95-312 Strabismus Scissors 4", straight
V95-314 Strabismus Scissors 4", curved

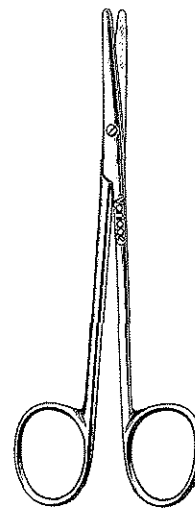

V95-312

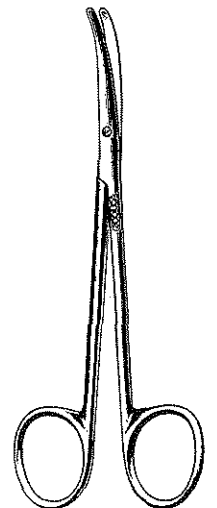

V95-314

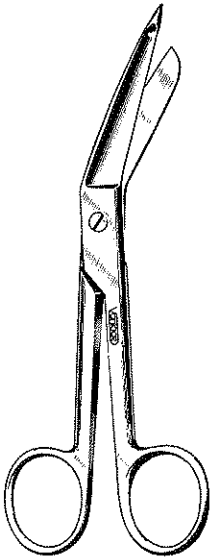

V95-500 to 524

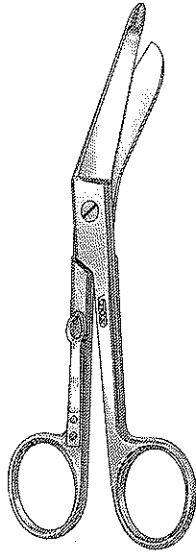

V95-532

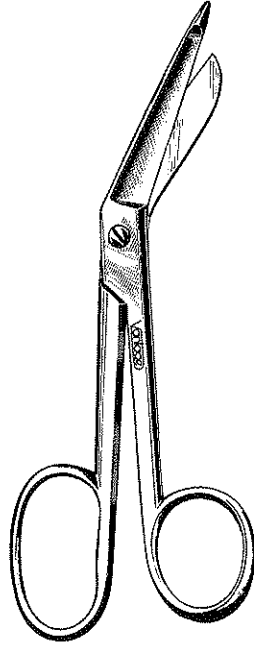

V95-550

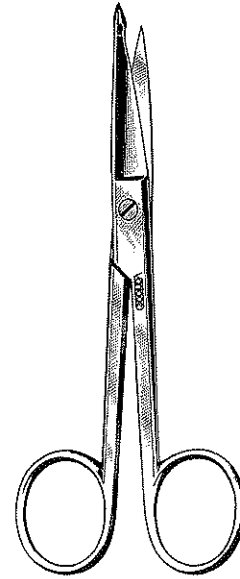

V95-560

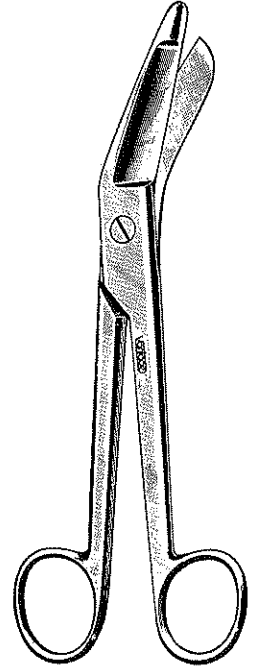

V95-568

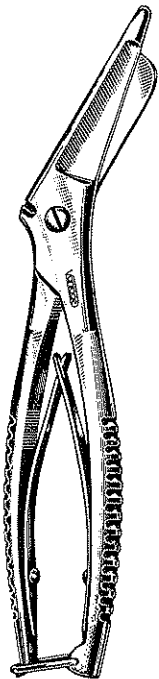

V95-600

LISTER BANDAGE SCISSORS

Stainless	Size
V95-500SS	3½"
V95-502SS	4½"
V95-504SS	5½"
V95-506SS	7¼"

- V95-524 LISTER Bandage Scissors 5½", gold plated
- V95-532 LISTER Bandage Scissors 5½", w/pocket clip
- V95-550 LISTER Bandage Scissors 8", w/one large ring
- V95-560 KNOWLES Bandage Scissors 5½"
- V95-568 ESMARCH Plaster Shears 8"
- V95-600 First Aid Shears 8½", with wire cutter, one serrated blade



V96-1 to
V96-18



V96-40 to
V96-46

FULL
SIZE



V96-104



V96-106

FULL
SIZE

FULL
SIZE

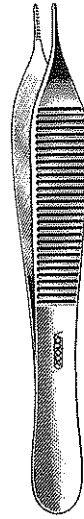

V96-118



V96-120

FULL
SIZE

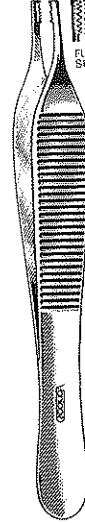

V96-124

FULL
SIZE



V96-142

FULL
SIZE

DRESSING FORCEPS, Serrated Tips

V96-1	3½"	V96-10	6"
V96-4	4½"	V96-14	8"
V96-6	5"	V96-16	10"
V96-8	5½"	V96-18	12"

TISSUE FORCEPS, 1 × 2 Teeth

V96-40	4½"	V96-44	5½"
V96-42	5"	V96-46	6"

- V96-104 SEMKEN Dressing Forceps 5", serrated
- V96-106 SEMKEN Tissue Forceps 5", 1 × 2 teeth
- V96-118 ADSON Dressing Forceps 4¾", serrated
- V96-120 ADSON Tissue Forceps 4¾", 1 × 2 teeth
- V96-124 BROWN-ADSON Tissue Forceps 4¾", 7 × 7 teeth
- V96-142 RUSSIAN Tissue Forceps 6"
- V96-197 JANSEN Bayonet Dressing Forceps 6¼", serrated

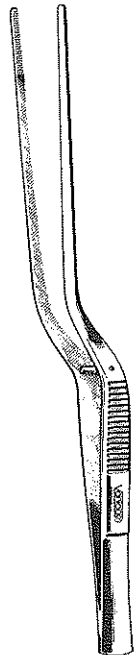

V96-197

Splinter Forceps

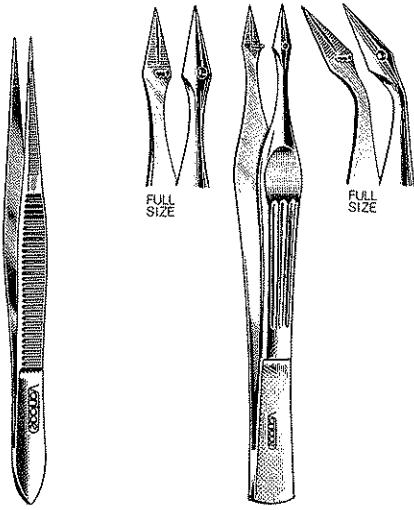

V96-300
V96-304

V96-312
V96-314



V96-316
V96-318

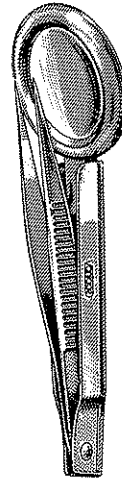

V96-329

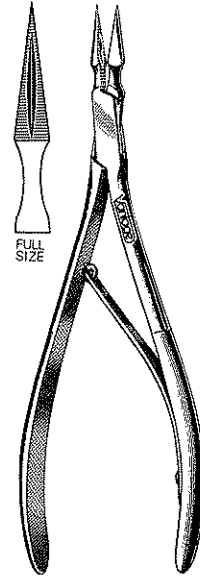

V96-336



V96-400



V96-410

- V96-300 Regular Splinter Forceps 3½", fine serrated points
- V96-304 Regular Splinter Forceps 4½", fine serrated points
- V96-312 WALTER Splinter Forceps 4½", straight
- V96-314 WALTER Splinter Forceps 4½", curved
- V96-316 FEILCHENFELD Splinter Forceps 3"
- V96-318 FEILCHENFELD Splinter Forceps 4½"
- V96-329 Splinter Forceps 3", with magnifier, in pocket case (ideal for removal of ticks)
- V96-336 VIRTUS Splinter Forceps 6"
- V96-400 Splinter Liberator 5", in reversible handle
- V96-410 Splinter Removal Kit (No. V96-312 and No. V96-400 in case)

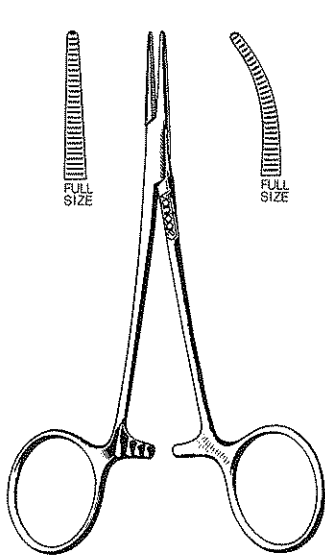

V97-2
V97-4

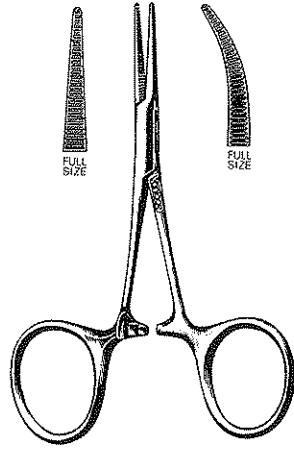

V97-24
V97-26

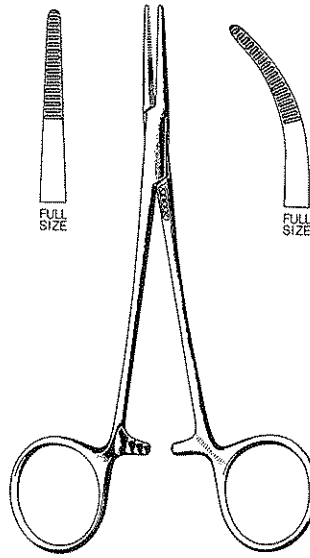

V97-30
V97-32

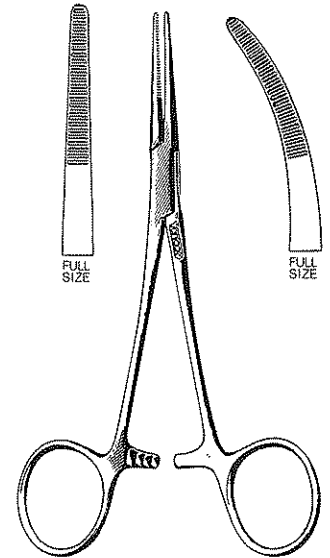

V97-36
V97-38

V97-2 HALSTEAD Mosquito Forceps 5", straight
V97-4 HALSTEAD Mosquito Forceps 5", curved

V97-24 HARTMAN Mosquito Forceps 3½", straight
V97-26 HARTMAN Mosquito Forceps 3½", curved

V97-30 PROVIDENCE HOSPITAL Forceps 5½", straight
V97-32 PROVIDENCE HOSPITAL Forceps 5½", curved

V97-36 KELLY Forceps 5½", straight
V97-38 KELLY Forceps 5½", curved

V97-42 CRILE Forceps 5½", straight
V97-44 CRILE Forceps 5½", curved
V97-46 CRILE Forceps 6¼", straight
V97-48 CRILE Forceps 6¼", curved

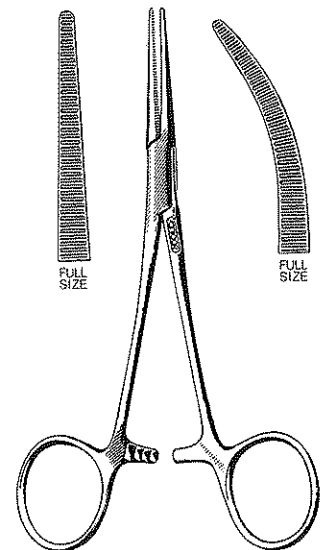

V97-42 to V97-48

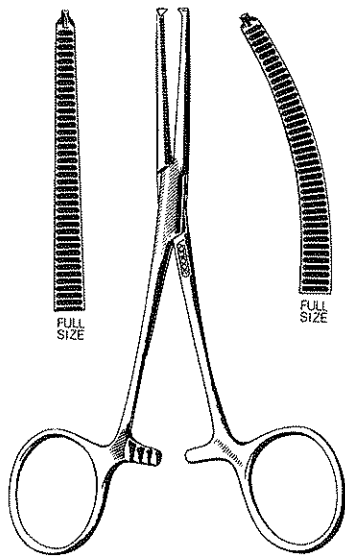

V97-66
V97-68

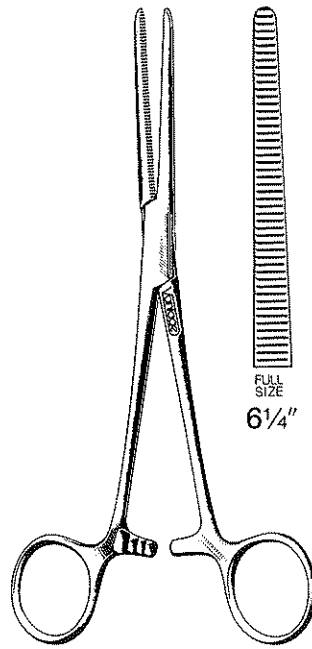

V97-118 to V97-128

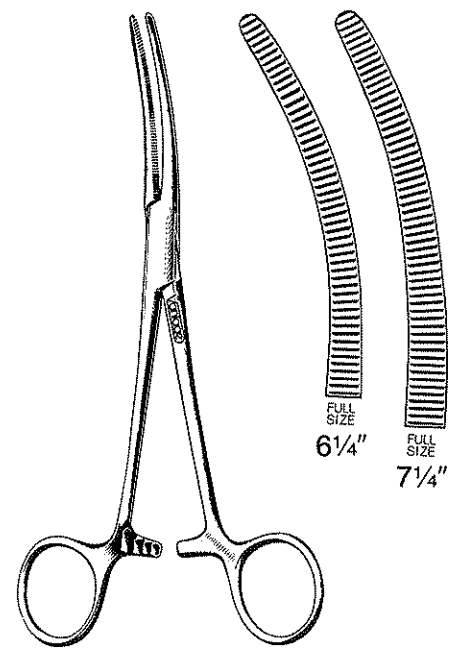

V97-136 to V97-146

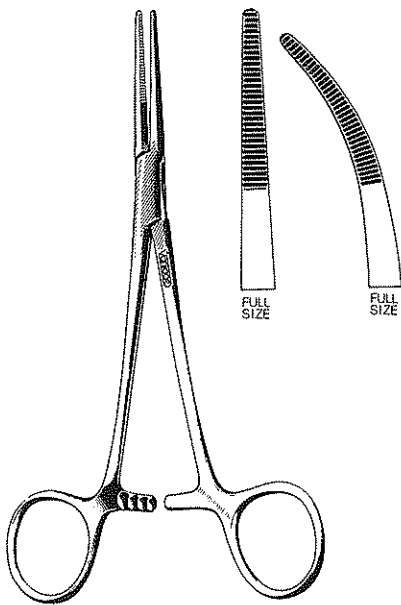

V97-92
V97-94

V97-66 KOCHER Forceps 5½", straight, 1 × 2 teeth
V97-68 KOCHER Forceps 5½", curved, 1 × 2 teeth

V97-92 RANKIN Forceps 6¼", straight
V97-94 RANKIN Forceps 6¼", curved

ROCHESTER PEAN FORCEPS

Straight	Length	Curved
V97-118	5½"	V97-136
V97-120	6¼"	V97-138
V97-122	7¼"	V97-140
V97-124	8"	V97-142
V97-126	9"	V97-144
V97-128	10¼"	V97-146

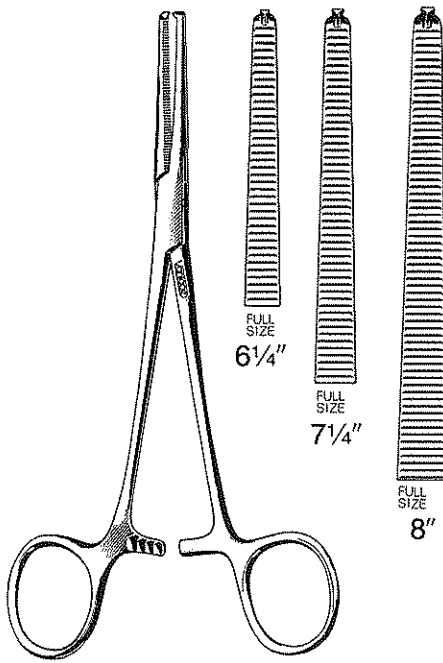

V97-150 to 157

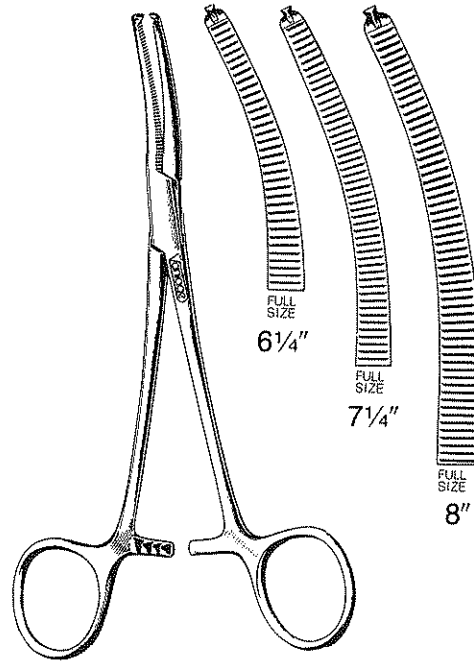

V97-160 to 167

ROCHESTER OCHSNER FORCEPS, 1 x 2 Teeth

Straight	Length	Curved
V97-150	6 1/4"	V97-160
V97-152	7 1/4"	V97-162
V97-154	8"	V97-164
V97-156	9"	V97-166
V97-157	10"	V97-167

- V97-170 ROCHESTER CARMALT Forceps 6 1/4", straight
- V97-172 ROCHESTER CARMALT Forceps 6 1/4", curved
- V97-180 ROCHESTER CARMALT Forceps 8", straight
- V97-182 ROCHESTER CARMALT Forceps 8", curved

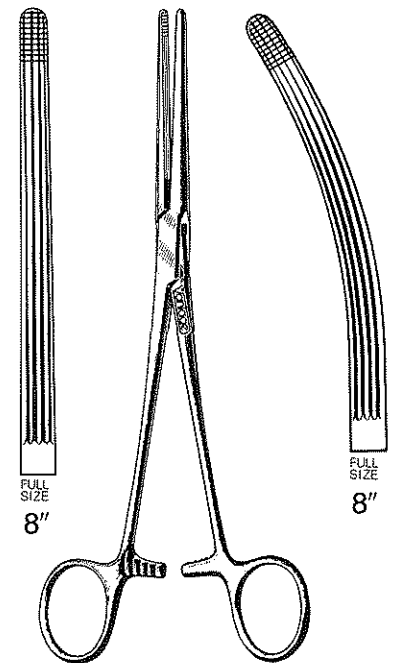

V97-170 to 182

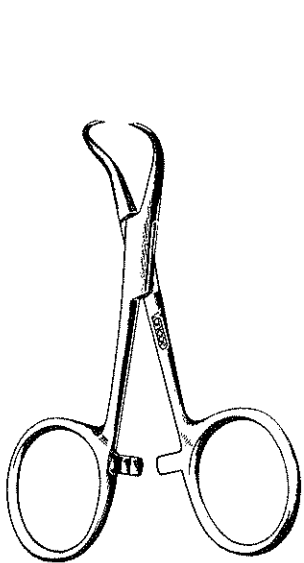

V97-504

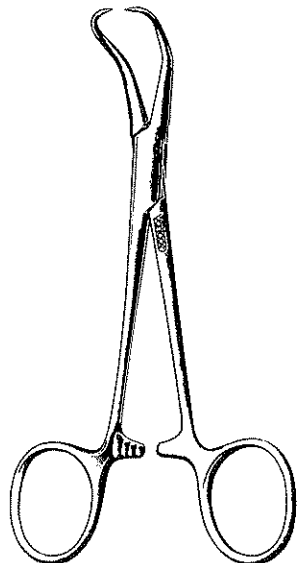

V97-506

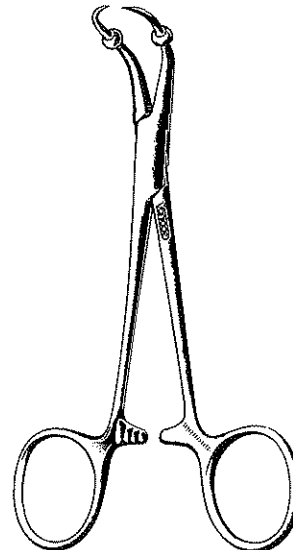

V97-510

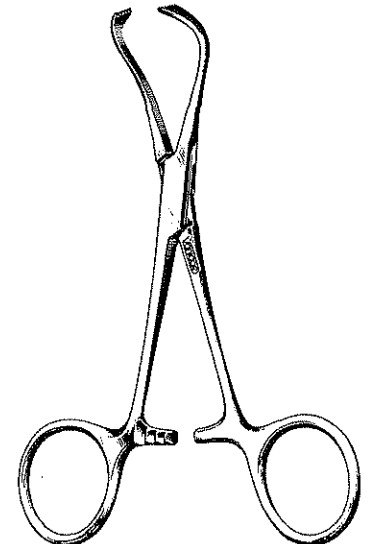

**V97-514
V97-515**

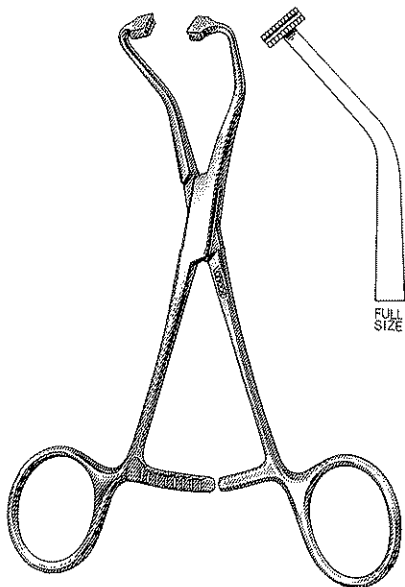

V97-520



V97-500

- V97-500** JONES Towel Clamp 3½"
- V97-504** BACKHAUS Towel Clamp 3½"
- V97-506** BACKHAUS Towel Clamp 5¼"
- V97-510** ROEDER Towel Clamp 5¼", with ball stops
- V97-514** LORNA Non-Perforating Towel Clamp 3½"
- V97-515** LORNA Non-Perforating Towel Clamp 5¼"
- V97-520** PEERS Non-Perforating Towel Clamp 5¾"

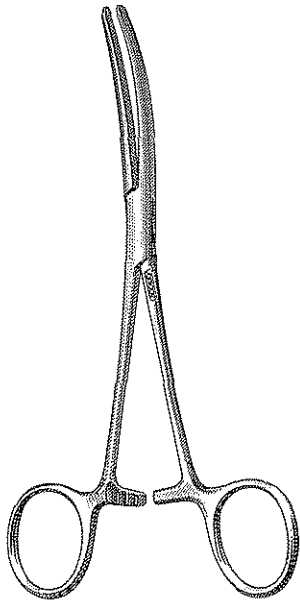

V97-584

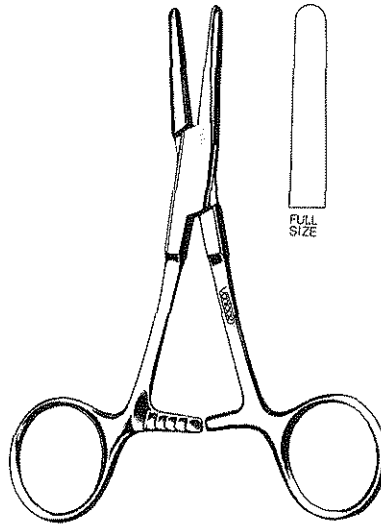

V97-588

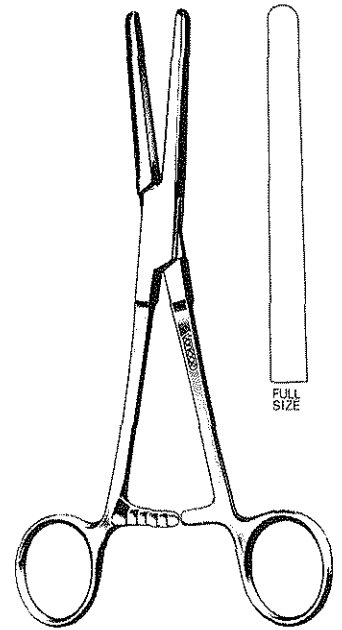

V97-590

- V97-584 ST. VINCENTS Tube Occluding Clamp 6¼", curved smooth jaws
- V97-588 English Pattern Tube Occluding Clamp 4½", straight smooth jaws
- V97-590 PRESBYTERIAN HOSPITAL Tube Occluding Clamp 7", smooth jaws heavy pattern
- V97-585 U.S. Pattern Tube Occluding Clamp 5¾", straight serrated jaws, with stop
- V97-591 U.S. Pattern Tube Occluding Clamp 7½", straight serrated jaws, with stop

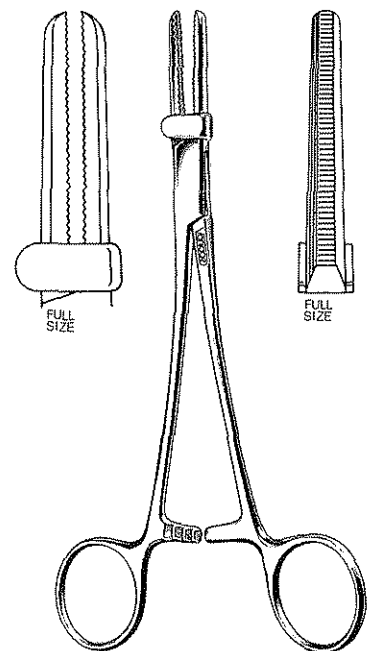

V97-585
V97-591

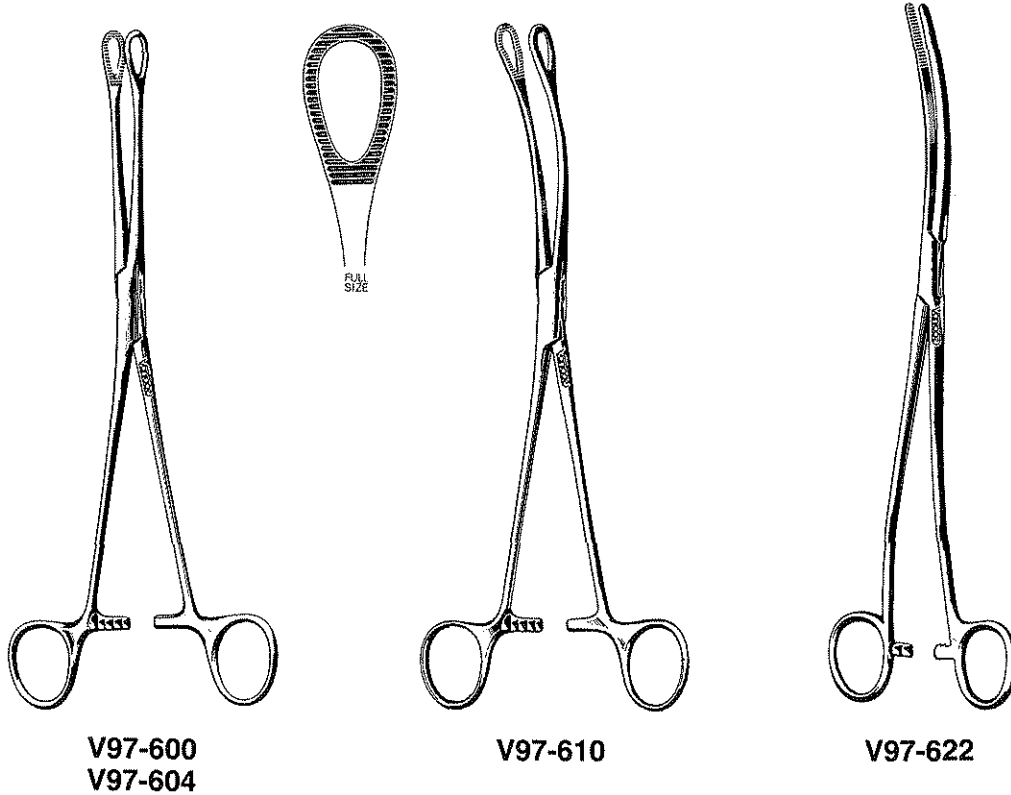

- V97-600** FOERSTER Sponge Forceps 9½", straight, serrated jaws
- V97-604** FOERSTER Sponge Forceps 7", straight, serrated jaws
- V97-610** FOERSTER Sponge Forceps 9½", curved, serrated jaws
- V97-622** BOZEMAN Dressing Forceps 10½", double curved

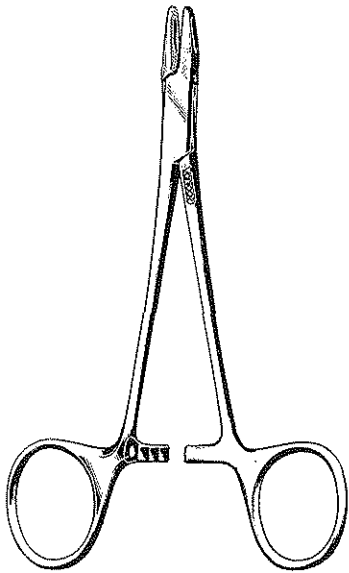

V98-2

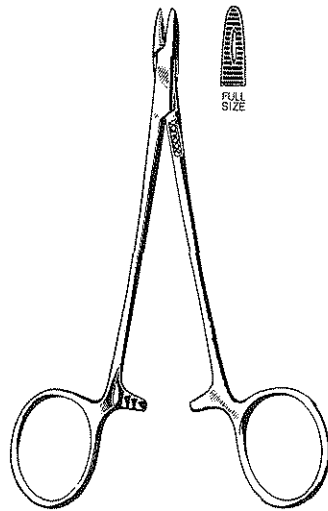

V98-4

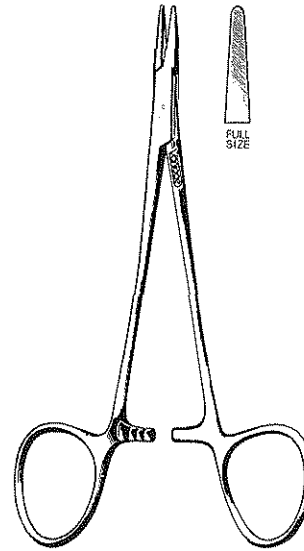

V98-6

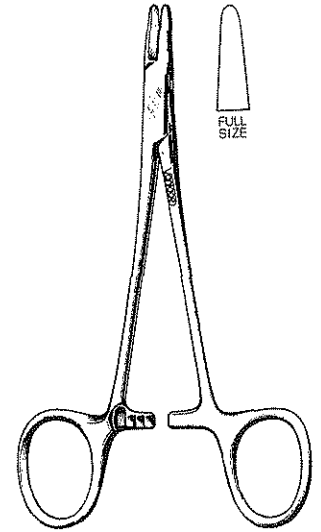

V98-8

- V98-2 COLLIER Needle Holder 5", fenestrated jaws
- V98-4 DERF Needle Holder 4¾"
- V98-6 WEBSTER Needle Holder 5", smooth jaws
- V98-8 HALSEY Needle Holder 5", smooth jaws
- V98-28 MATHIEU Needle Holder, 5½", with spring handles

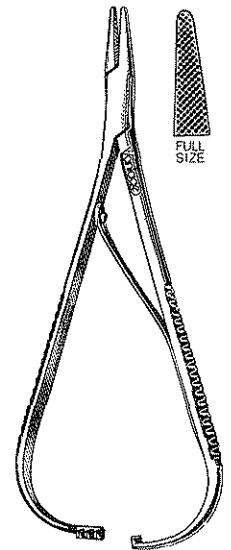

V98-28

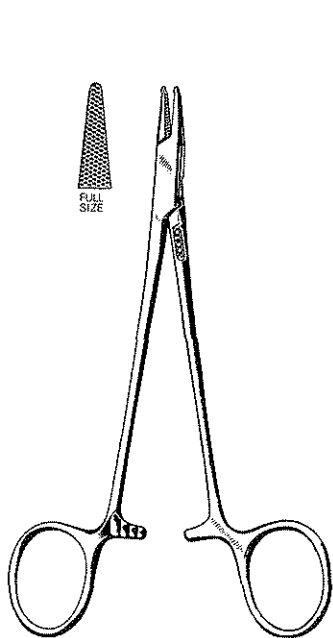

V98-40

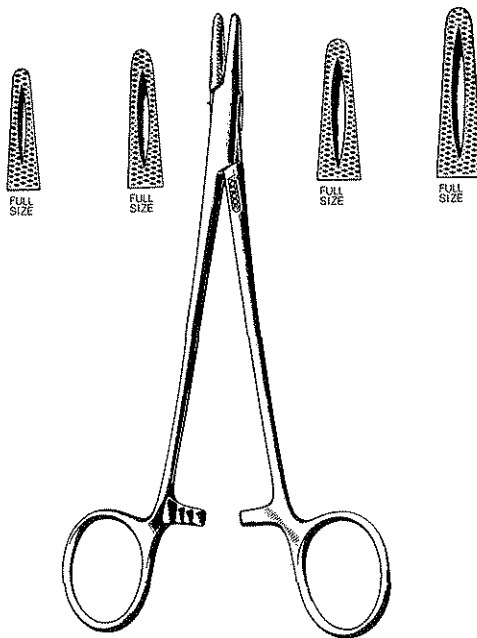

V98-42 to 48

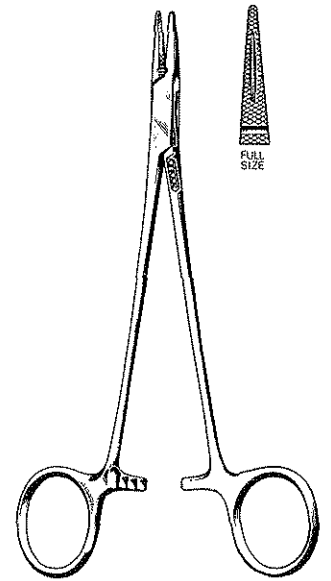

V98-50

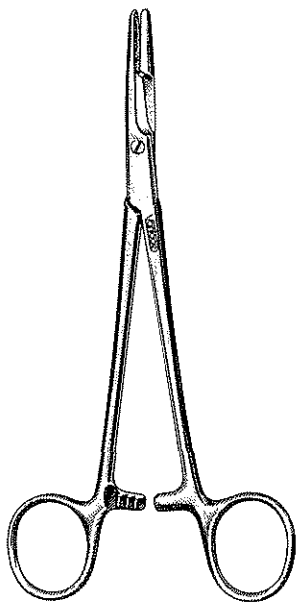

V98-15 to 17

V98-40 BAUMGARTNER Needle Holder 5½"

V98-42 MAYO-HEGAR Needle Holder 5"

V98-44 MAYO-HEGAR Needle Holder 6"

V98-46 MAYO-HEGAR Needle Holder 7"

V98-48 MAYO-HEGAR Needle Holder 8"

V98-50 CRILE-WOOD Needle Holder 6", delicate jaws

V98-15 OLSEN-HEGAR Needle Holder 5½" with Suture Scissors

V98-16 OLSEN-HEGAR Needle Holder 6½" with Suture Scissors

V98-17 OLSEN-HEGAR Needle Holder 7½" with Suture Scissors

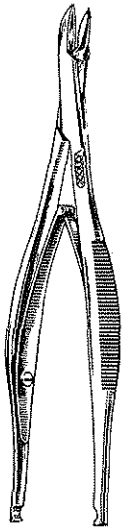

V99-60

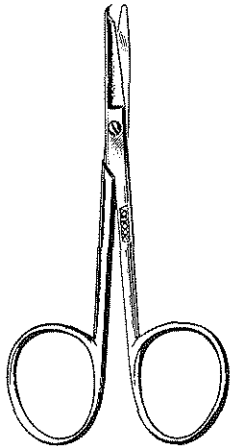

V99-100

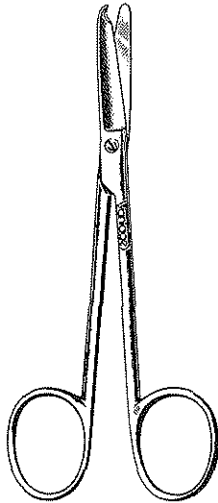

V99-102

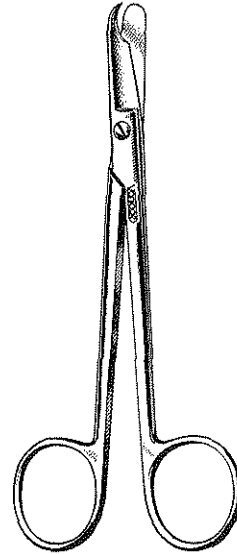

V99-104

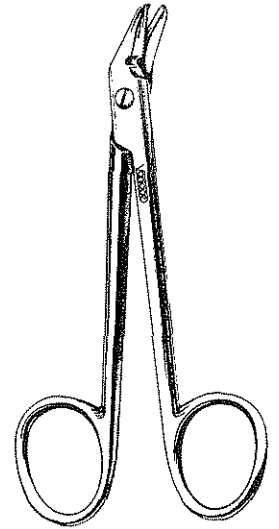

V99-124

V99-60 MICHEL Clip Applying and Removing Forceps 5", double end

V99-100 SPENCER Stitch Scissors 3½", delicate

V99-102 LITTAUER JUNIOR Stitch Scissors 4½"

V99-104 LITTAUER Stitch Scissors 5½", standard pattern

V99-124 Wire Cutting Scissors 4¾", angular, one serrated blade

V918-1652 Eye Suture Scissors 3¾", curved, very delicate pointed blades

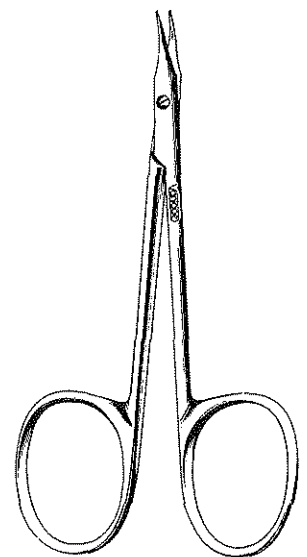

V918-1652

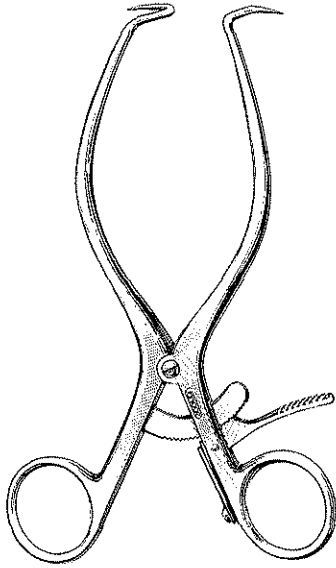

V911-366

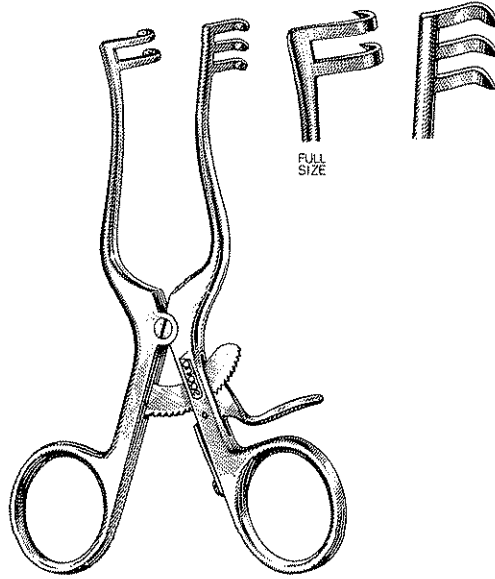

V911-600 to 602

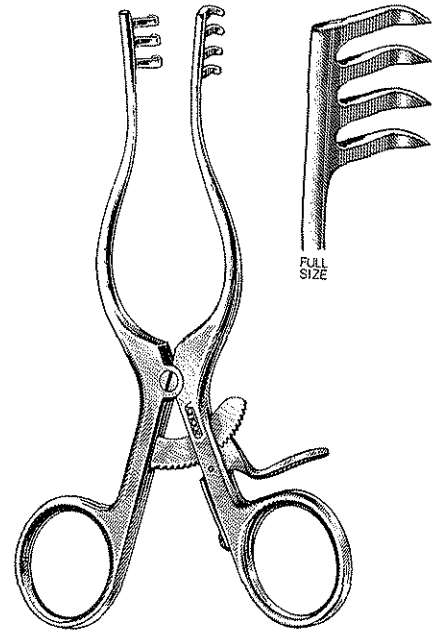

V911-608 to 614

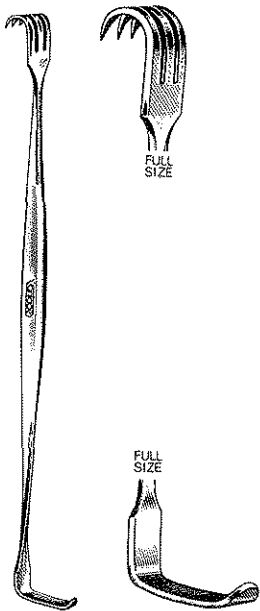

V911-74

V911-74 SENN Retractor 6³/₈" , sharp prongs, double end

V911-366 GELPI Retractor 6³/₄" , with grip lock ratchet

WEITLANER RETRACTORS w/grip lock ratchets

w/Sharp Teeth

- V911-600** 4" , 2 × 3 teeth
- V911-608** 5¹/₂" , 3 × 4 teeth
- V911-614** 6¹/₂" , 3 × 4 teeth

w/Blunt Teeth

- V911-602**
- V911-610**
- V911-616**

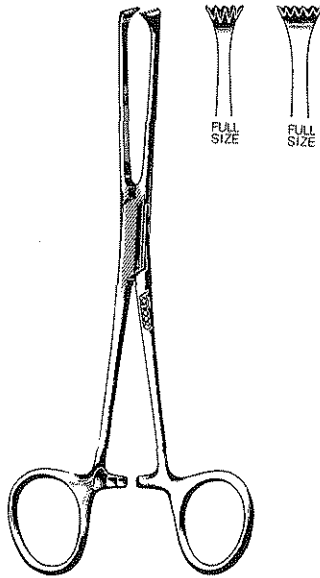

V916-6 to 10

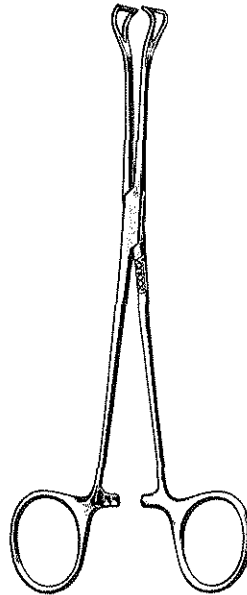

V916-44

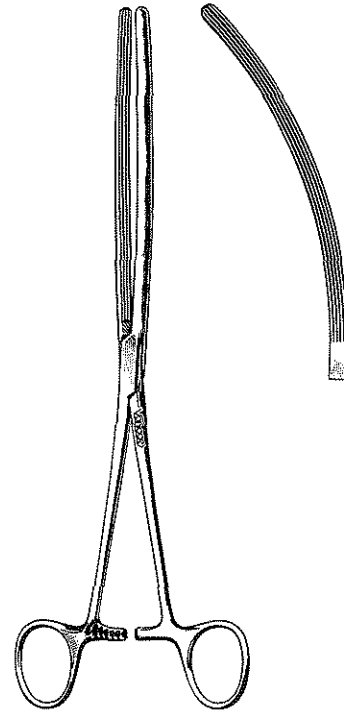

V916-160
V916-162

- V916-6 ALLIS Tissue Forceps 6", 4 × 5 teeth
- V916-8 ALLIS Tissue Forceps 6", 5 × 6 teeth
- V916-10 ALLIS Tissue Forceps 7¼", 5 × 6 teeth

V916-44 BABCOCK Tissue Forceps 6¼", 8mm wide jaws

- V916-160 DOYEN Intestinal Forceps 9", straight, longitudinal serrations
- V916-162 DOYEN Intestinal Forceps 9", curved, longitudinal serrations

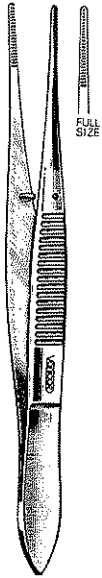

V918-780

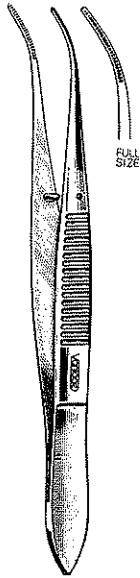

V918-782

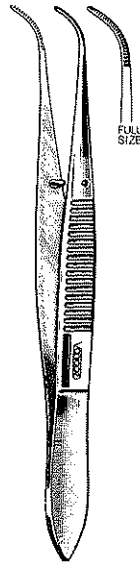

V918-784



V918-786

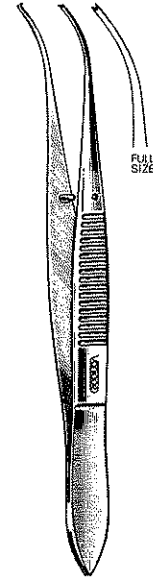

V918-788

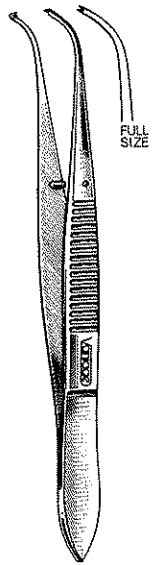

V918-790



V918-412

- V918-412** TYRELL HOOK 5", sharp point
- V918-780** Eye Dressing Forceps 4", straight, serrated tips
- V918-782** Eye Dressing Forceps 4", half curved, serrated tips
- V918-784** Eye Dressing Forceps 4", full curved, serrated tips
- V918-786** Iris Tissue Forceps 4", straight, 1 x 2 teeth
- V918-788** Iris Tissue Forceps 4", half curved, 1 x 2 teeth
- V918-790** Iris Tissue Forceps 4", full curved, 1 x 2 teeth

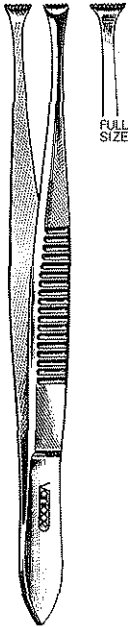

V918-850

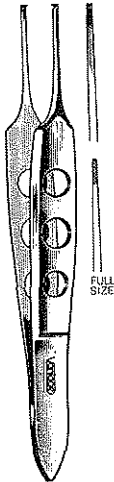

V918-866
V918-868



V918-1110

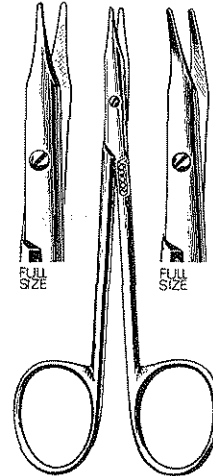

V918-1462
V918-1466

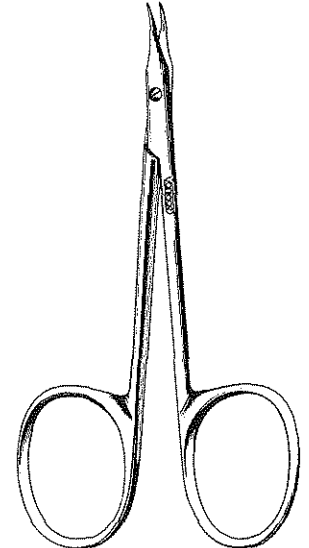

V918-1652

V918-850 GRAEFE Fixation Forceps 4 $\frac{3}{8}$ ", w/fine teeth

V918-866 BISHOP-HARMON Dressing Forceps 3 $\frac{3}{8}$ ", serrated tips

V918-868 BISHOP-HARMON Tissue Forceps 3 $\frac{3}{8}$ ", 1 x 2 teeth

V918-1110 BERGH Cilia Forceps 3 $\frac{1}{2}$ ", fine serrated jaws

V918-1462 STEVENS Tenotomy Scissors 4 $\frac{1}{8}$ ", straight, blunt points

V918-1466 STEVENS Tenotomy Scissors 4 $\frac{1}{8}$ ", curved, blunt points

V918-1652 Eye Suture Scissors 3 $\frac{3}{4}$ ", curved, very delicate pointed blades

V918-1828 CASTROVIEJO Needle Holder 5 $\frac{1}{2}$ ", straight jaws, with catch

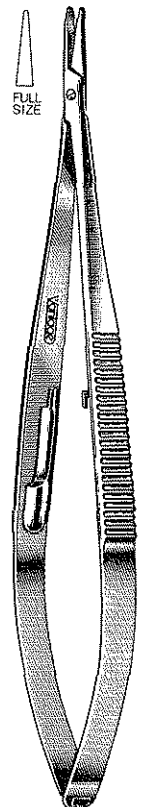

V918-1828



V919-280 to 288

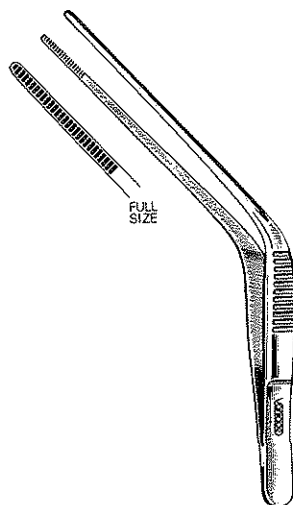

V919-350

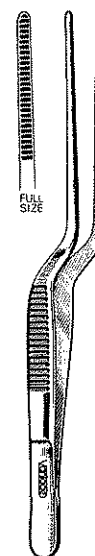

V919-370

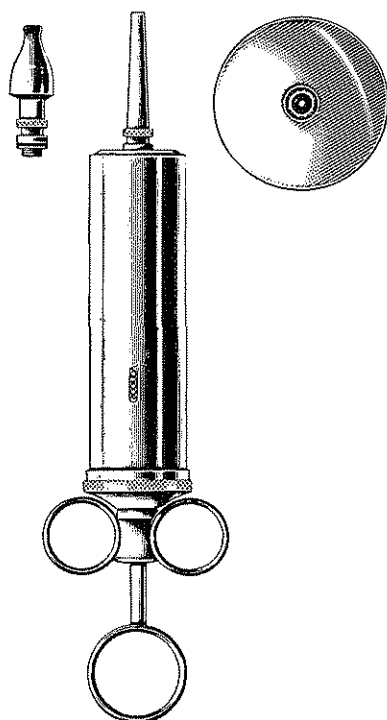

V919-381 to 385

- V919-280** BUCK Ear Curette, straight, blunt, size 00
- V919-282** BUCK Ear Curette, straight, blunt, size 0
- V919-284** BUCK Ear Curette, straight, blunt, size 1
- V919-286** BUCK Ear Curette, straight, blunt, size 2
- V919-288** BUCK Ear Curette, straight, blunt, size 3

V919-350 WILDE Ear Forceps 5", angular, with serrated tips

V919-370 LUCAE Ear Forceps 5½", bayonet shape, with serrated tips

METAL EAR SYRINGES, complete with one short bulbous tip, one tapered tip and shield, chrome

- V919-381** 2 oz. capacity
- V919-383** 3 oz. capacity
- V919-385** 4 oz. capacity

- V919-390** Short Bulbous Tip only
- V919-394** Tapered Tip only
- V919-396** Shield only

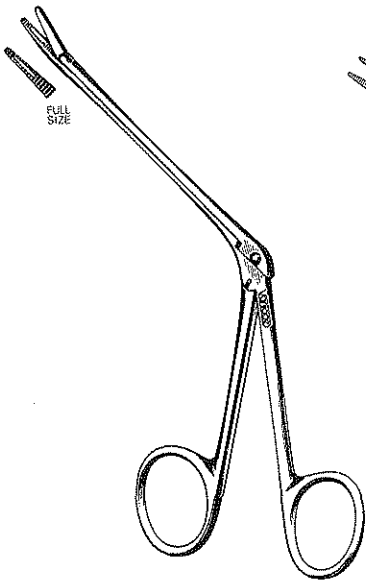

V919-434

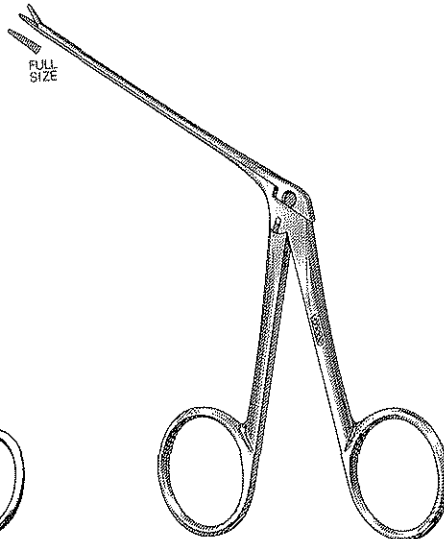

V919-434A

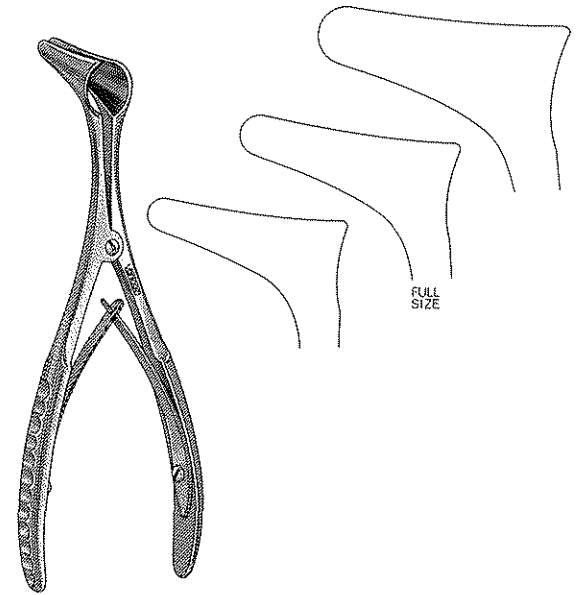

V920-2 to V920-4

V919-434 HARTMAN-NOYES Alligator Ear Forceps, 3¼" shaft, serrated jaws

V919-434A HARTMAN-NOYES Alligator Ear Forceps, 3¼" shaft, serrated jaws, extra delicate

V920-2 VIENNA Nasal Speculum, large size

V920-3 VIENNA Nasal Speculum, medium size

V920-4 VIENNA Nasal Speculum, small size

V920-140 NOYES Alligator Forceps, 5½" shaft, serrated jaws

V920-142 NOYES Alligator Forceps, 6½" shaft, serrated jaws

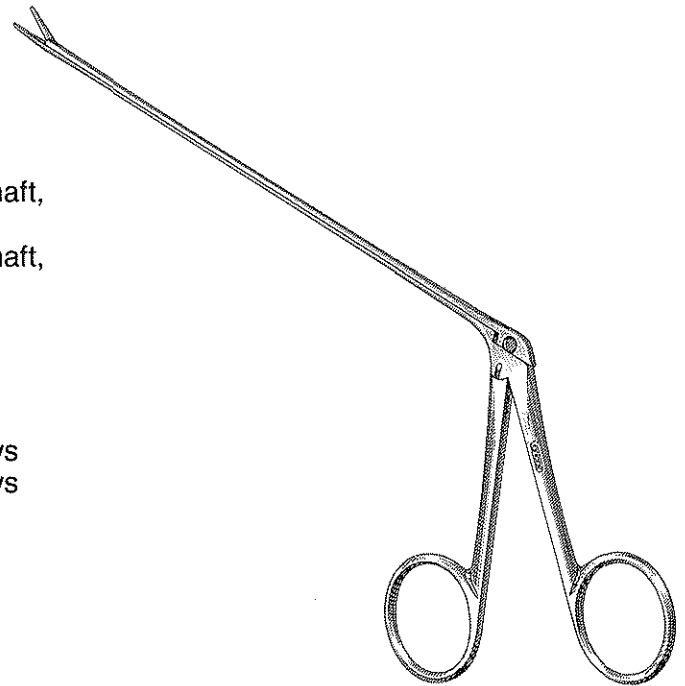

V920-140
V920-142

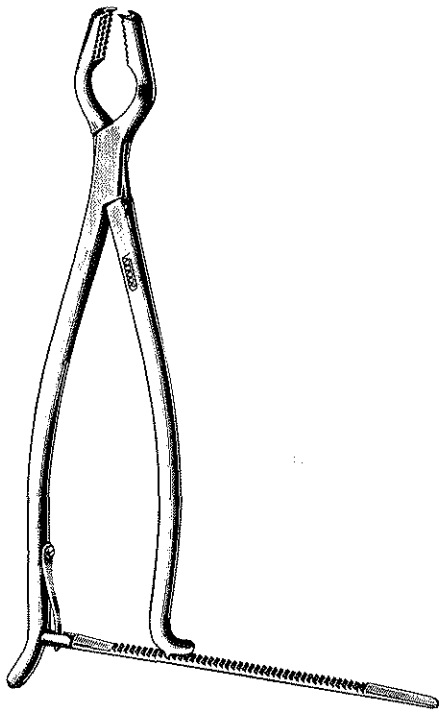

V927-4
V927-7

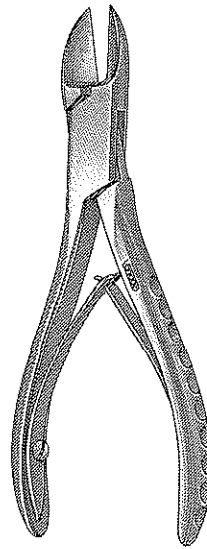

V927-1390

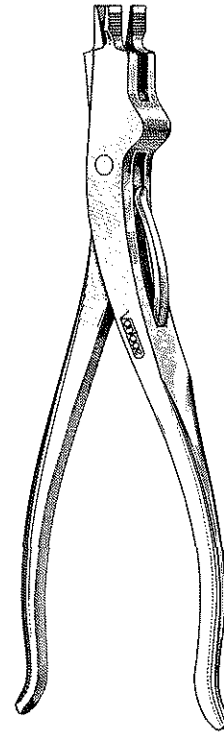

V927-3100

V927-4
V927-7

KERN Bone Holding Forceps 9-1/2", with ratchet
KERN Bone Holding Forceps 6-1/2", with ratchet

V927-1390

LISTON Bone Cutting Forceps 5-1/2", straight jaws

V927-3100

Cast Spreader 9", 3 prongs, with spring handle

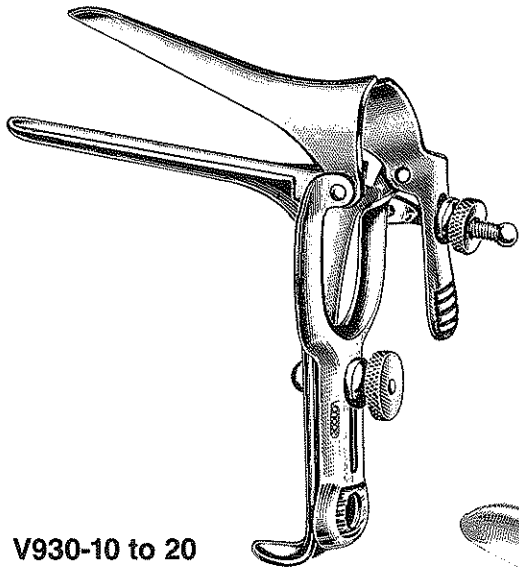

V930-10 to 20

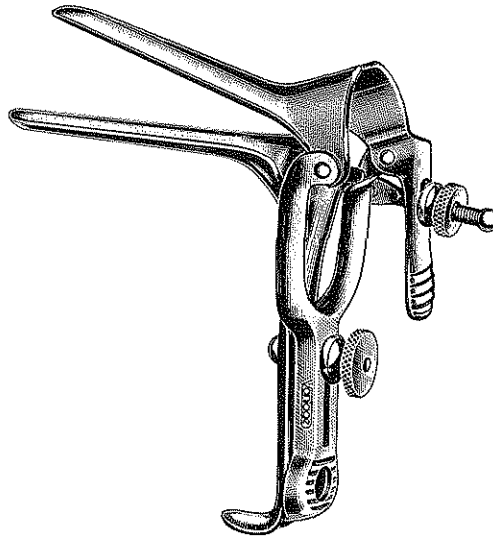

V930-50 to 60

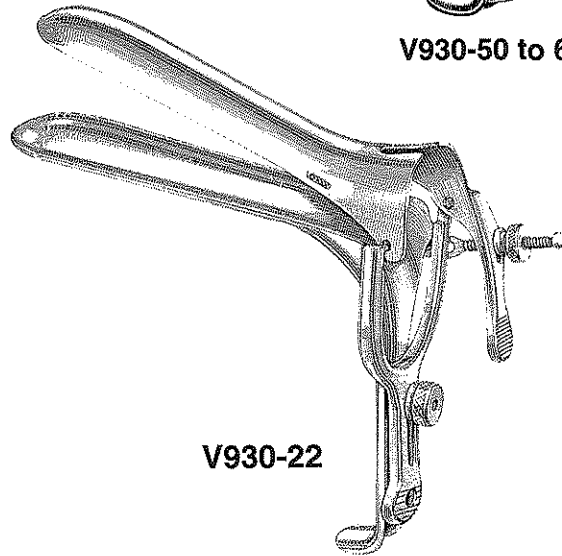

V930-22

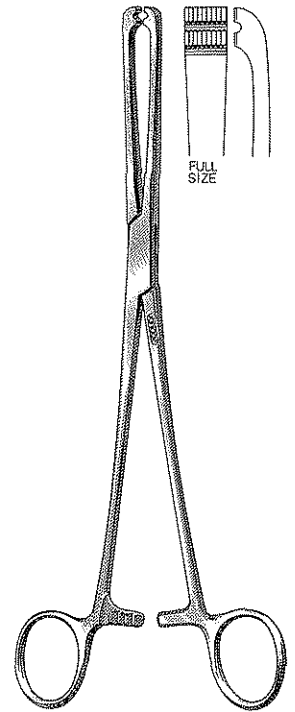

V930-856

- V930-10
- V930-15
- V930-20
- V930-22

GRAVES Vaginal Speculum, small size
 GRAVES Vaginal Speculum, medium size
 GRAVES Vaginal Speculum, large size
 GRAVES Vaginal Speculum, extra large

- V930-50
- V930-55
- V930-60
- V930-61

PEDERSON Vaginal Speculum, virgin size
 PEDERSON Vaginal Speculum, medium size
 PEDERSON Vaginal Speculum, large size
 PEDERSON Vaginal Speculum, extra long (not pictured)

- V930-856

Atraumatic Tenaculum Forceps 9", straight, with 1/4" jaws

- V930-965

SCHROEDER Tenaculum Forceps 9-1/2", straight

- V930-996

Polyp Forceps 10-1/2", angled shanks, delicate narrow jaws

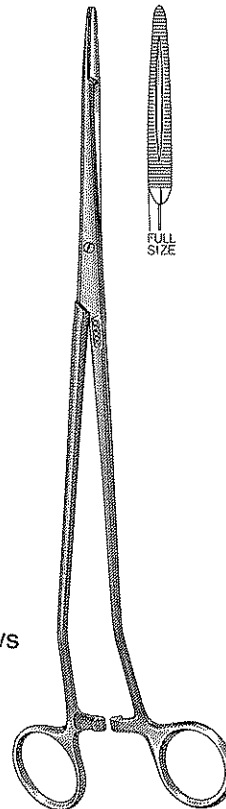

V930-996

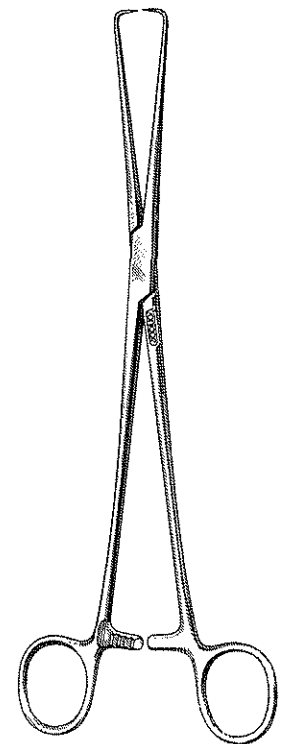

V930-965

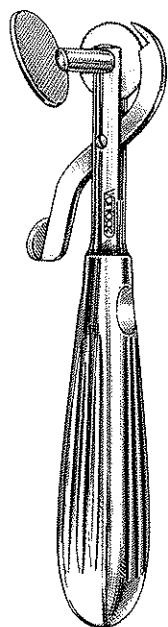

V933-140
V933-142



V933-200

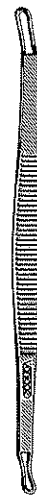

V933-201

V933-140 Finger Ring Cutter 6¼", chrome plated with tool steel saw blade
V933-142 Replacement Saw Blade

V933-200 SCHAMBERG Comedone Extractor, open ends
V933-201 SCHAMBERG Comedone Extractor, small end crimped

A		
Accessories, Anesthesia.....	1	
Accessories, Diagnostic.....	1	
Accessories, Sterilizing.....	1	
Adson Dressing Forceps.....	5	
Adson Tissue Forceps.....	5	
Alligator Ear Forceps.....	21	
Allis Tissue Forceps.....	17	
Anesthesia Accessories.....	1	
Anesthesia Instruments.....	1	
Atraumatic Tenaculum Forceps.....	23	
B		
Babcock Tissue Forceps.....	17	
Backhaus Towel Clamps.....	10	
Bandage Scissors.....	4	
Baumgartner Needle Holder.....	14	
Bayonet Dressing Forceps.....	5	
Bergh Cilia Forceps.....	19	
Bishop-Harmon Dressing Forceps.....	19	
Bone Cutting Forceps.....	22	
Bone Holding Forceps.....	22	
Bozeman Dressing Forceps.....	12	
Brown-Adson Tissue Forceps.....	5	
Buck Ear Curettes.....	20	
C		
Carmalt Forceps.....	9	
Cast Spreader.....	22	
Castroviejo Needle Holder.....	19	
Catheter Introducing Forceps.....	1	
Cilia Forceps.....	19	
Clamps, Towel.....	10	
Clamps, Tube Occluding.....	11	
Clip Applying and Removing Forceps.....	15	
Collier Needle Holder.....	13	
Comedone Extractors.....	24	
Crile Forceps.....	7	
Crile-Wood Needle Holder.....	14	
Curettes.....	20	
Curettes, Ear.....	20	
Cutter, Ring.....	24	
D		
Derf Needle Holder.....	13	
Dermal Instruments.....	24	
Diagnostic Accessories.....	1	
Diagnostic Instruments.....	1	
Dissecting Scissors.....	3	
Doyen Intestinal Forceps.....	17	
Dressing Forceps.....	5, 12, 18, 19	
E		
Ear Forceps.....	20, 21	
Ear Instruments.....	20, 21	
Ear Specula.....	20	
Endotracheal Catheter Forceps.....	1	
English Pattern Tube Occluding Clamp.....	11	
Esmarch Plaster Shears.....	4	
Extractors, Comedone.....	24	
Eye Dressing Forceps.....	18	
Eye Instruments.....	18, 19	
Eye Suture Scissors.....	15, 19	
F		
Feilchenfeld Splinter Forceps.....	6	
First Aid Scissors.....	4	
First Aid Shears.....	4	
Fixation Forceps.....	19	
Foerster Sponge Forceps.....	12	
Forceps, Alligator.....	21	
Forceps, Atraumatic Tenaculum.....	23	
Forceps, Bayonet.....	5	
Forceps, Bone Cutting.....	22	
Forceps, Bone Holding.....	22	
Forceps, Catheter Introducing.....	1	
Forceps, Cilia.....	19	
Forceps, Clip Applying.....	15	
Forceps, Clip Removing.....	15	
Forceps, Dressing.....	5, 12, 18, 19	
Forceps, Ear.....	20, 21	
Forceps, Endotracheal.....	1	
Forceps, Eye Dressing.....	18	
Forceps, Fixation.....	19	
Forceps, Grasping.....	1	
Forceps, Hemostatic.....	7-9	
Forceps, Intestinal.....	17	
Forceps, Iris.....	18	
Forceps, Mosquito.....	7	
Forceps, Polyp.....	23	
Forceps, Splinter.....	6	
Forceps, Sponge.....	12	
Forceps, Sterilizer.....	1	
Forceps, Tenaculum.....	23	
Forceps, Tissue.....	5, 17-19	
Forceps, Tongue Seizing.....	1	
Forceps, Tubing.....	11	
G		
Gelpi Retractor.....	16	
Graefe Fixation Forceps.....	19	
Grasping Forceps.....	1	
Graves Vaginal Speculum.....	23	
Gruber Ear Specula.....	20	
Gynecological Instruments.....	23	
H		
Halsey Needle Holder.....	13	
Halstead Mosquito Forceps.....	7	
Hartman Mosquito Forceps.....	7	
Hartman-Noyes Ear Forceps.....	21	
Hemostatic Forceps.....	7-9	
I		
Instruments, Anesthesia.....	1	
Instruments, Dermal.....	24	
Instruments, Diagnostic.....	1	
Instruments, Ear.....	20, 21	
Instruments, Eye.....	18, 19	
Instruments, Gynecological.....	23	
Instruments, Intestinal.....	17	
Instruments, Nasal.....	21	
Instruments, Orthopedic.....	22	
Instruments, Sterilizing.....	1	
Intestinal Instruments.....	17	
Iris Scissors.....	3	
Iris Tissue Forceps.....	18	
J		
Jansen Dressing Forceps.....	5	
Jones Towel Clamp.....	10	
K		
Kelly Forceps.....	7	
Kern Bone Holding Forceps.....	22	
Kit, Splinter Removal.....	6	
Knowles Bandage Scissors.....	4	
Kocher Forceps.....	8	
L		
Liberator, Splinter.....	6	
Lister Bandage Scissors.....	4	
Liston Bone Cutting Forceps.....	22	
Littauer Junior Stitch Scissors.....	15	
Littauer Stitch Scissors.....	15	
Lorna Towel Clamps.....	10	
Lucae Ear Forceps.....	20	
M		
Magill Forceps.....	1	
Mathieu Needle Holder.....	13	
Mayo Scissors.....	3	
Mayo-Hegar Needle Holders.....	14	
Metal Ear Syringes.....	20	
Metzenbaum, Scissors.....	3	
Michel Clip Applying Forceps.....	15	
Mosquito Forceps.....	7	
N		
Nasal Instruments.....	21	
Nasal Speculum.....	21	
Needle Holders.....	13, 14, 19	
Neurological Pinwheel.....	1	
Non-Perforating Towel Clamps.....	10	
Noyes Alligator Forceps.....	21	

O

Ochsner Forceps	9
Olsen-Hegar Needle Holders	14
Operating Scissors	2, 3
Orthopedic Instruments	22

P

Pean Forceps	8
Pederson Vaginal Speculum	23
Pinwheel, Wartenberg	1
Plaster Shears	4
Polyp Forceps	23
Presbyterian Hospital Tube Occluding Clamp	11
Providence Hospital Forceps	7

R

Rankin Forceps	8
Retractors	16
Retractors, Self-Retaining	16
Ring Cutter	24
Rochester Carmalt Forceps	9
Rochester Ochsner Forceps	9
Rochester Pean Forceps	8
Roeder Towel Clamp	10
Russian Tissue Forceps	5

S

Schamberg Comedone Extractors	24
Schroeder Tenaculum Forceps	23
Scissors, Bandage	4
Scissors, Dissecting	3

Scissors, Eye Suture	15, 19
Scissors, First Aid	4
Scissors, Iris	3
Scissors, Operating	2, 3
Scissors, Stitch	15
Scissors, Strabismus	3
Scissors, Tenotomy	19
Scissors, Wire Cutting	15
Self-Retaining Retractors	16
Semkin Dressing Forceps	5
Semkin Tissue Forceps	5
Senn Retractor	16
Shapleigh Ear Curettes	20
Shears, First Aid	4
Shears, Plaster	4
Specula, Ear	20
Speculum, Nasal	21
Speculum, Vaginal	23
Spencer Stitch Scissors	15
Splinter Forceps	6
Splinter Liberator	6
Splinter Removal Kit	6
Sponge Forceps	12
Spreader, Cast	22
St. Vincent's Tube Occluding Clamp	11
Sterilizing Accessories	1
Sterilizing Instruments	1
Stevens Tenotomy Scissors	19
Stitch Scissors	15
Strabismus Scissors	3
Suture Scissors	19

Suture Sundries	15
Syringes, Ear	20

T

Tenaculum Forceps	23
Tenotomy Scissors	19
Three-Prong, Sterilizer Forceps	1
Tissue Forceps	5, 17-19
Tongue Seizing Forceps	1
Towel Clamps	10
Tube Occluding Clamps	11
Tubing Forceps	11
Tyrell Hook	18

U

U.S. Pattern Tube Occluding Clamps	11
------------------------------------	----

V

Vaginal Speculum	23
Vienna Nasal Speculum	21
Virtus Splinter Forceps	6

W

Walter Splinter Forceps	6
Wartenberg Pinwheel	1
Webster Needle Holder	13
Weitlaner Retractors	16
Wilde Ear Forceps	20
Wire Cutting Scissors	15

Y

Young Tongue Seizing Forceps	1
------------------------------	---